



Tapered roller bearings



8 Tapered roller bearings

Designs and variants	669	Bearing designations	691
Single row tapered roller bearings	669	Metric bearings	691
Basic design bearings	669	Inch bearings	691
Application-specific bearings	669		
Bearings with a flanged outer ring	670	Designation system	692
Matched tapered roller bearings	670		
Matched bearings arranged face-to-face	670	Product tables	
Matched bearings arranged back-to-back	670	8.1 Metric single row tapered roller bearings	694
Matched bearings arranged in tandem	671	8.2 Inch single row tapered roller bearings	714
Double row tapered roller bearings	671	8.3 Single row tapered roller bearings with a flanged outer ring	742
TDO design bearings	671	8.4 Matched bearings arranged face-to-face	744
TDI design bearings	672	8.5 Matched bearings arranged back-to-back	754
Variants/features	674	8.6 Matched bearings arranged in tandem	760
SKF Explorer bearings	675	8.7 Double row tapered roller bearings, TDO design ..	762
Cages	675	8.8 Double row tapered roller bearings, TDI design ...	766
Bearing data	676		
(Dimension standards, tolerances, internal clearance, preload, permissible misalignment)			
Loads	680		
(Minimum load, equivalent dynamic bearing load, equivalent static bearing load)			
Calculating the axial load for bearings mounted singly or paired in tandem	681		
Calculating the radial load acting on matched bearings ..	683		
Comparative load ratings for double row tapered roller bearings	685		
Temperature limits	685		
Permissible speed	686		
Design considerations	687	Other tapered roller bearings	
Single row and matched tapered roller bearings	687	Bearings with Solid Oil	1023
Adjustment procedure	687	Four-row tapered roller bearings	→ skf.com/bearings
Fits	687	INSOCOAT bearings	→ contact SKF
		NoWear coated bearings	→ contact SKF
Mounting	690	Hub units for industrial, automotive, railway and off-highway applications	→ contact SKF
Double row tapered roller bearings	690		
Load zone	690		

8 Tapered roller bearings

More information

General bearing knowledge 17

Bearing selection process 59

Lubrication 109

Bearing interfaces 139

Seat tolerances for standard conditions 148

Selecting internal clearance or preload 182

Sealing, mounting and dismounting 193

Mounting instructions for individual bearings → skf.com/mount

SKF bearing maintenance handbook ISBN 978-91-978966-4-1

Tapered roller bearings have tapered inner and outer ring raceways as well as tapered rollers. They are designed to accommodate combined loads, i.e. simultaneously acting radial and axial loads. The projection lines of the raceways meet at a common point on the bearing axis (apex point A, **fig. 1**) to provide a true rolling action and therefore low frictional moments during operation. The axial load carrying capacity of tapered roller bearings increases with increasing contact angle α . The size of the contact angle, which is usually between 10° and 30° , is related to the calculation factor e (**product tables, page 694**); the larger the value of e , the larger the contact angle.

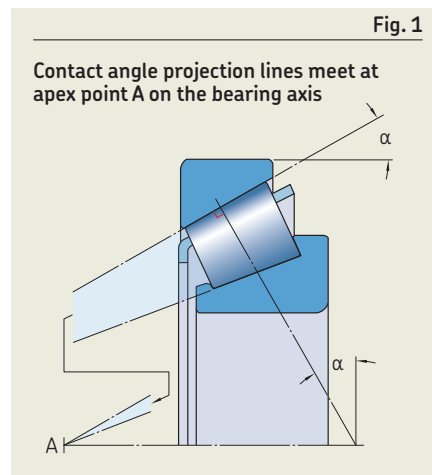

Bearing features

- **Low friction**

The optimized roller end design and surface finish on the flange (fig. 2) promote lubricant film formation, resulting in lower friction. This also reduces frictional heat and flange wear. In addition, the bearings can better maintain preload and run at reduced noise levels.

- **Long service life**

The crowned raceway profiles of basic design bearings and the logarithmic raceway profiles of SKF Explorer bearings optimize the load distribution along the contact surfaces, reduce stress peaks at the roller ends (fig. 3), and reduce the sensitivity to misalignment and shaft deflection compared with conventional straight raceway profiles (fig. 4).

- **Enhanced operational reliability**

Optimized surface finish on the contact surfaces of the rollers and raceways supports the formation of a hydrodynamic lubricant film.

Load distribution and stress reduction

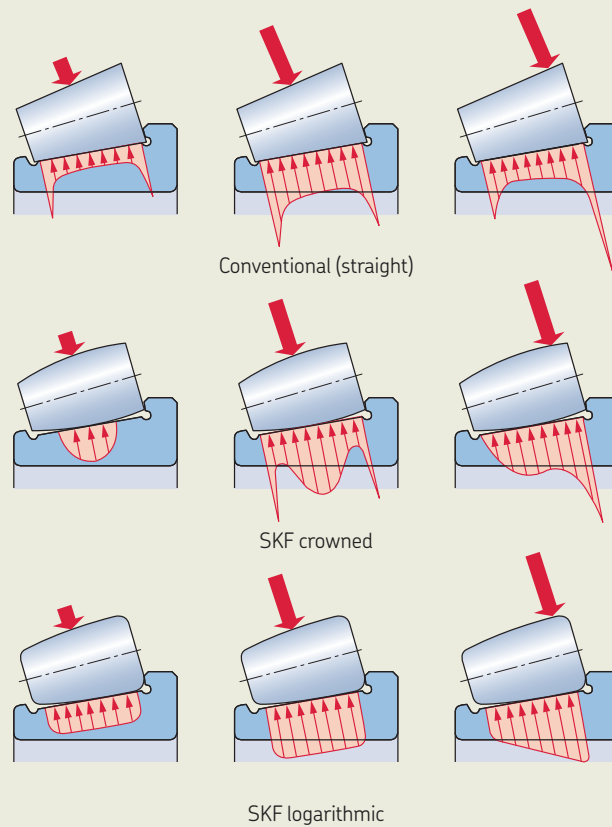

Fig. 3

Raceway profiles

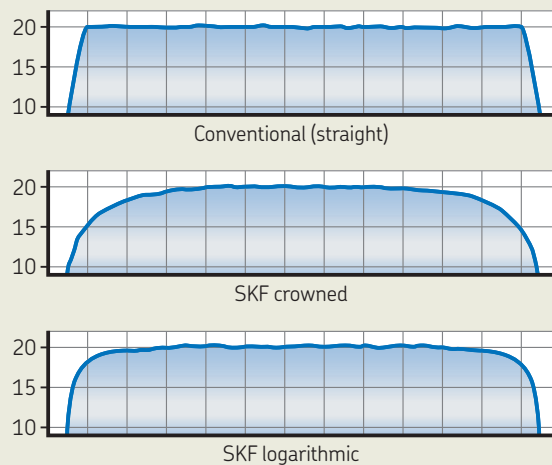
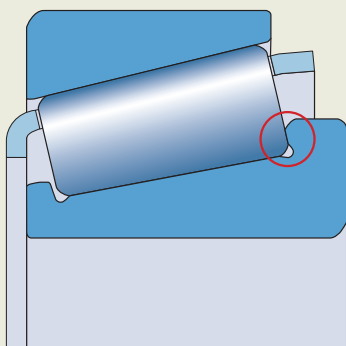

Fig. 4

Fig. 2

Roller end / flange contact area



8 Tapered roller bearings

- **Consistency of roller profiles and sizes**

The rollers incorporated in SKF tapered roller bearings are manufactured to such close dimensional and geometrical tolerances that they are practically identical. This provides optimal load distribution, reduces noise and vibration, and enables preload to be set more accurately.

- **Rigid bearing application**

A single row tapered roller bearing is typically adjusted against a second tapered roller bearing. By applying a preload, a rigid bearing application can be achieved.

- **Running-in period with reduced temperature peaks**

Tapered roller bearings typically have a running-in period, during which a conventional design tapered roller bearing experiences a significant amount of friction, resulting in wear. This effect is noticed as a temperature spike (diagram 1). With SKF tapered roller bearing designs, friction, frictional heat and wear are significantly reduced, provided the bearings are mounted and lubricated correctly.

- **Separable and interchangeable**

Depending on the design, tapered roller bearings are separable and components of same-sized bearings are fully interchangeable. For example, single row tapered roller bearings are separable (fig. 5), i.e. the inner ring with roller and cage assembly (cone) can be mounted separately from the outer ring (cup). This facilitates mounting, dismounting and also maintenance inspection routines.

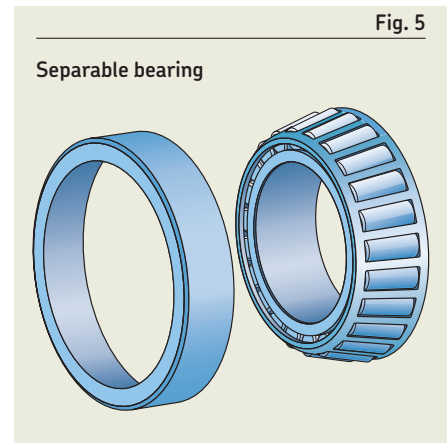

SKF manufactures tapered roller bearings in many designs, series and sizes. In addition to the bearings presented in this catalogue, SKF supplies tapered roller bearings for special application requirements. This assortment includes:

- *Four-row tapered roller bearings*
→ skf.com/bearings
- hub units for industrial, automotive, railway and off-highway applications
→ contact SKF

On request, SKF can also supply customized tapered roller bearings for various operating conditions to meet the customer and application requirements.

Diagram 1

Typical temperature behaviour of tapered roller bearings during the running-in period (approximate values)

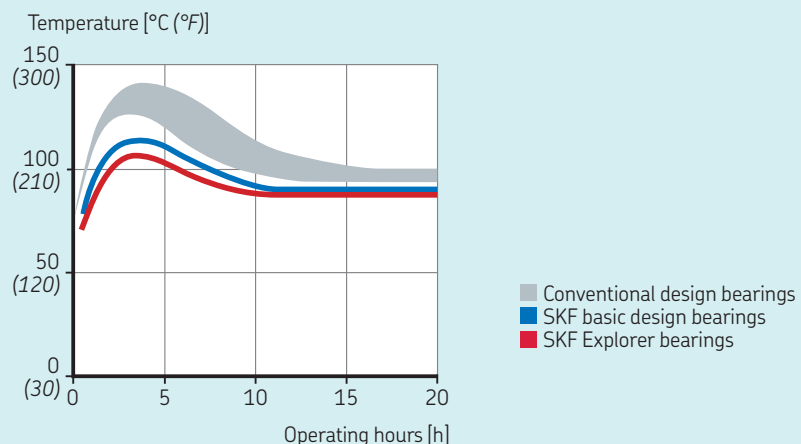

Designs and variants

Single row tapered roller bearings

SKF single row tapered roller bearings (fig. 6) are available in many designs and variants and in many series and sizes, including:

- basic design bearings
- application-specific bearings
- bearings with a flanged outer ring
- SKF Explorer bearings (page 675)

Basic design bearings

- have a design and internal geometry that provide long service life
- have crowned raceway profiles and an optimized surface finish of the inner ring guide flange that enables them to run cooler and consume less lubricant than conventional design bearings
- have load rating values that are in accordance with ISO and even above (product tables, page 762)
- offer a cost-effective solution for standard industrial applications

On request, SKF can also supply any inner ring with roller and cage assembly (cone) or any outer ring (cup) separately (fig. 7).

Application-specific bearings

For applications where the bearings are subjected to unique operating conditions, SKF manufactures customized single row tapered roller bearings on request. To meet the needs of these particular applications, SKF manufactures, for example, pinion or low-friction bearings with the following features:

Pinion bearings

- are designed for pinion shafts in the differentials of automotive transmissions to provide a constant, accurate gear mesh
- have very narrow geometrical tolerances and high preload capability
- have special friction characteristics and can be axially adjusted within narrow limits using the friction-torque method
- have an internal design that supports the formation of a hydrodynamic lubricant film to substantially reduce friction, and consequently the operating temperature, during the running-in period
- retain their preload setting when mounted, lubricated and maintained properly
- are identified by the designation suffix CL7C

Low-friction bearings

- are designed to meet the ever-increasing demands to reduce friction and energy use
- optimize a reduction in friction through their internal geometry, number of rollers, surface finish and redesign of their cage
- have a frictional moment that is at least 30% lower when compared with a same-sized SKF standard bearing
- normally do not need a running-in procedure because their optimized contact profiles provide optimum load distribution and they experience only a small, controlled loss of initial preload
- generate less frictional heat and therefore enable extended lubrication intervals or operation at higher speeds
- have a roller and cage assembly with a lower mass and therefore reduced inertial forces in the bearing, which reduce the risk of skidding and smearing
- are typically used in automotive and industrial transmissions

Fig. 6

Single row tapered roller bearing

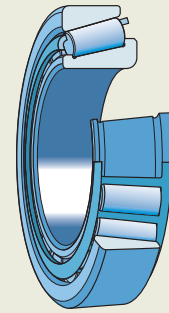

Fig. 7

Separately packed components



8 Tapered roller bearings

Bearings with a flanged outer ring

SKF also manufactures certain sizes of single row tapered roller bearings with a flange on the outer ring (fig. 8). These bearings are easy to locate axially in the housing. The housing bore can be manufactured more easily and more cost-effectively because housing shoulders are not required.

Matched tapered roller bearings

The SKF assortment of matched single row tapered roller bearings (fig. 9) is based on popular sizes of single row tapered roller bearings. Depending on the application requirements, matched tapered roller bearings are available in different designs and variants:

- matched bearings arranged face-to-face
- matched bearings arranged back-to-back
- matched bearings arranged in tandem
- basic design and SKF Explorer bearings (page 675)

The matched bearings listed in the product tables constitute the basic SKF assortment. SKF can supply other matched bearings on request.

Depending on the design, matched bearings can locate the shaft axially in both directions with a specific axial clearance or preload. Also depending on the design, these bearings can provide a relatively stiff bearing arrangement.

The bearings and ring spacer(s) are matched in production, are delivered as a set and are ready-to-mount.

Matched bearings arranged face-to-face

- have load lines that converge toward the bearing axis (fig. 10)
- can accommodate a limited amount of misalignment
- can accommodate axial loads in both directions
- are supplied with an intermediate outer ring spacer as a set

Matched bearings arranged back-to-back

- have load lines that diverge toward the bearing axis (fig. 11)
- provide a relatively stiff bearing arrangement
- can accommodate tilting moments
- can accommodate axial loads in both directions
- are supplied with intermediate inner and outer ring spacers as a set

Fig. 8

Bearing with a flanged outer ring

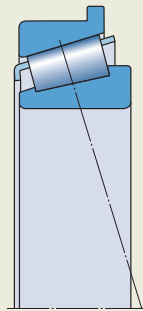

Fig. 9

Matched single row tapered roller bearings

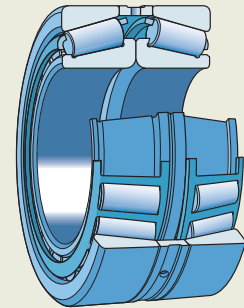

Fig. 10

Matched bearings arranged face-to-face



Fig. 11

Matched bearings arranged back-to-back

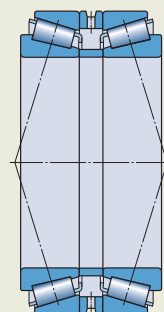

Matched bearings arranged in tandem

- have load lines that are parallel (fig. 12)
- share radial and axial loads equally
- are used when the load carrying capacity of a single bearing is inadequate
- can accommodate axial loads in one direction only
 - If axial loads act in both directions, a third bearing must be added and adjusted against the tandem pair.
- are supplied with intermediate inner and outer ring spacers as a set

Double row tapered roller bearings

SKF manufactures double row tapered roller bearings in the TDO (fig. 13) and TDI (fig. 14) designs, in many variants and with different features.

Depending on the design, these bearings can accommodate heavy radial loads, axial loads in both directions and have a high degree of stiffness. Therefore, they provide a stiff bearing arrangement and locate the shaft in both directions with a specific axial clearance or preload. Because of their second row of rollers, double row tapered roller bearings are suitable for heavy radial and axial loads.

Double row tapered roller bearings are typically used in gearboxes, hoisting equipment, rolling mills and machines in the mining industry, e.g. tunnelling machines.

TDO design bearings

- have one double row outer ring (double cup) and two inner rings with roller and cage assemblies (cones), usually with an intermediate ring between the two inner rings (fig. 13)
- have rows of rollers arranged back-to-back (load lines diverge toward the bearing axis), which enable stiff arrangements and accommodate considerable tilting moments
- are ready-to-mount units, manufactured with the predetermined axial clearance or preload
- can be used either as locating or non-locating bearings:
 - for non-locating arrangements, the axial displacement should take place between the outer ring and the housing bore
 - bearings with a blind hole or locating slot in the outer ring can be used with a cylindrical pin engaged in the hole or slot to prevent the outer ring from turning in its seat

SKF manufactures TDO design bearings in many variants (table 1, page 672).

Fig. 12

Matched bearings arranged in tandem

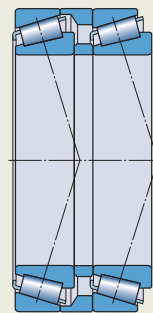

Fig. 13

TDO design

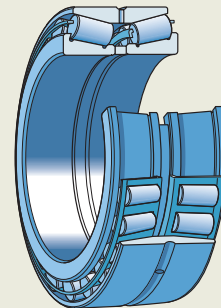
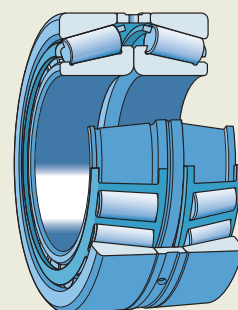

Fig. 14

TDI design



TDI design bearings

- have two outer rings (cups) and one double row inner ring with two roller and cage assemblies (double cone), usually with an intermediate ring between the two outer rings (fig. 14, page 671)
- have rows of rollers arranged face-to-face (load lines converge toward the bearing axis)
- are available open or capped with shields or seals
 - HNBR or FKM contact seal on both sides
- are ready-to-mount units, manufactured with the predetermined axial clearance or preload
- are designed primarily for use as locating bearings
- are available with a helical groove in the bore and/or lubrication grooves in the side faces of the bearing rings (fig. 15):
 - where a loose fit on the shaft is needed, these grooves counteract the disadvantage of a loose fit
 - when the inner ring turns on its seat under load, these grease-filled grooves enable lubricant to be supplied between the inner ring and seat surfaces
 - in addition, the grooves can absorb wear particles

SKF manufactures TDI design bearings in many variants (table 2).

Table 1

TDI design variants and characteristics

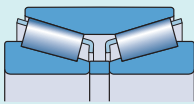
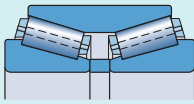
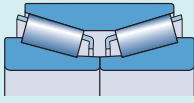
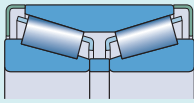
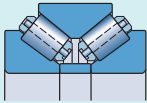
Design variant	Characteristics
TDO 	<ul style="list-style-type: none"> • intermediate ring between two inner rings • steel window-type cages
TD0.1 	<ul style="list-style-type: none"> • intermediate ring between two inner rings • steel pin-type cages (pierced rollers) for higher loads
TDON 	<ul style="list-style-type: none"> • without intermediate ring • inner rings abut each other • steel window-type cages
TD0/Z 	<ul style="list-style-type: none"> • intermediate ring between two inner rings • steel window-type cages • sheet steel shield on both sides
TDOS.1 	<ul style="list-style-type: none"> • steep contact angle α • for applications where high axial loads or high tilting moments occur in combination with radial loads • intermediate ring between two inner rings • steel pin-type cages (pierced rollers) for higher loads

⚠ WARNING

Seals made of FKM (fluoro rubber) exposed to an open flame or temperatures above 300 °C (570 °F) are a health and environmental hazard! They remain dangerous even after they have cooled.

Read and follow the safety precautions on [page 197](#).

Fig. 15

Helical groove in the bore and lubrication grooves in the side faces of the bearing rings

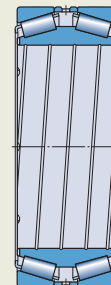
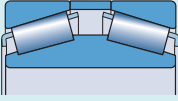
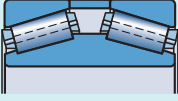
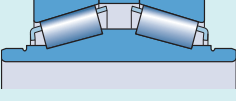
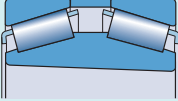
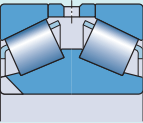
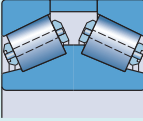
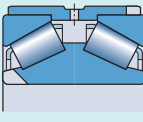

Table 2

TDI design variants and characteristics

Design variant	Characteristics
TDI 	<ul style="list-style-type: none"> • intermediate ring between two outer rings • steel window-type cages
TDI.1 	<ul style="list-style-type: none"> • intermediate ring between two outer rings • steel pin-type cages (pierced rollers) for higher loads
TDIE 	<ul style="list-style-type: none"> • intermediate ring between two outer rings • steel window-type cages • inner ring extensions at both sides <ul style="list-style-type: none"> – extensions are ground as counterface for seal lips
TDIT 	<ul style="list-style-type: none"> • intermediate ring between two outer rings • tapered bore, taper 1:12 • steel window-type cages
TDIS 	<ul style="list-style-type: none"> • steep contact angle α • for applications where high axial loads in combination with radial loads occur • intermediate ring between two outer rings • steel window-type cages • used in rolling mill applications with a loose fit on the roll neck and only subjected to purely axial load • the inner ring has one or more locating slots (notches) in one or both side faces to prevent it from turning on its seat • depending on the application, the bearings can be supplied with or without an intermediate ring between the two outer rings
TDIS.1 	<ul style="list-style-type: none"> • steep contact angle α • for applications where high axial loads in combination with radial loads occur • intermediate ring between two outer rings • steel pin-type cages (pierced rollers) for higher loads
TDIS.2 	<ul style="list-style-type: none"> • self-retaining unit with a retention sleeve over the outer rings • the outer rings are pressed into the sleeve • the deformation of the outer rings normally resulting from heavy axial loads is considerably reduced <ul style="list-style-type: none"> – as a consequence, the stress distribution in the rolling contacts is more favourable and extends bearing service life • the axial internal clearance is determined by the sleeve • preloading by means of springs is unnecessary • steep contact angle α • for applications where high axial loads in combination with radial loads occur • the simplified and economic design facilitates mounting, dismounting and also maintenance inspection routines



8 Tapered roller bearings

Optional TDI design bearings composed of four-row tapered roller bearing components

On request, TDI design bearings with dimensions different from those listed in the TDI design product table can be specially created as tailored double row bearings using standard components of SKF four-row tapered roller bearings in the TQO design, but without intermediate rings (TQO design, skf.com/go/17000-8-9). For example, it is possible to combine standard components as follows (fig. 16):

- two single row outer rings (cups)
- one double row inner ring (double cone)
- two roller and cage assemblies

This option may be advantageous as regards both price and delivery time and should be considered if sealed double row bearings are required, although this will require a non-standard inner ring. For details about this option, contact the SKF application engineering service.

Variants/features

SKF manufactures TDO and TDI design bearings in many variants and with different features. Bearing-related design variants and features are identified in the [product tables, page 762](#), under *Design variant/feature*. For other sizes, design variants or feature combinations not listed in the product tables, contact SKF. Design variants and features are identified by the following characters within designation suffixes:

Design variants

- E** Extended inner ring
- N** Without intermediate ring
- S** Steep contact angle α
- T** Tapered bore, taper 1:12
- .1** Steel pin-type cages and pierced rollers
- .2** Retention sleeve over the outer rings

Features

(TDO → [fig. 17](#), TDI → [fig. 18](#))

- C** Outer ring with blind hole to prevent, together with a cylindrical pin, the outer ring from turning in its seat
- D** Outer ring with annular groove and lubrication holes (TDO), inner ring with annular groove and lubrication holes (TDI)
- D0** Outer ring with annular groove and lubrication holes, without intermediate ring between the inner rings
- D2** Outer ring with annular groove and lubrication holes, intermediate ring with lubrication holes or lubrication grooves between the inner rings
- D3** Outer ring with annular groove and lubrication holes, intermediate ring with annular groove and lubrication holes or lubrication grooves between the inner rings
- G** Helical groove in the inner ring bore
- N** Two locating slots (notches) at 180° in one side face of the inner ring
- N1** One locating slot in each side face of the inner ring, at 180° to slot in opposite side face
- N2** Two locating slots at 180° in both side faces of the inner ring, at 90° to slots in opposite side face
- TN9** Glass fibre reinforced PA66 cage
- V** Contact seals on both sides
- W** Lubrication grooves in the side faces of the bearing rings
- W1** Lubrication grooves in the side faces of the inner ring(s)
- W0** Lubrication grooves in the side faces of the outer ring(s)
- X** Bearings with retention sleeve with annular groove and lubrication holes over the outer rings (TDI, replaced by design variant .2)

- XD** Outer ring with lubrication holes (TDO)
- Y** Bearing without intermediate ring between the outer rings
- Y2** Intermediate ring with annular groove and lubrication holes between the outer rings (TDI)
- Z** Sheet steel shield on both sides

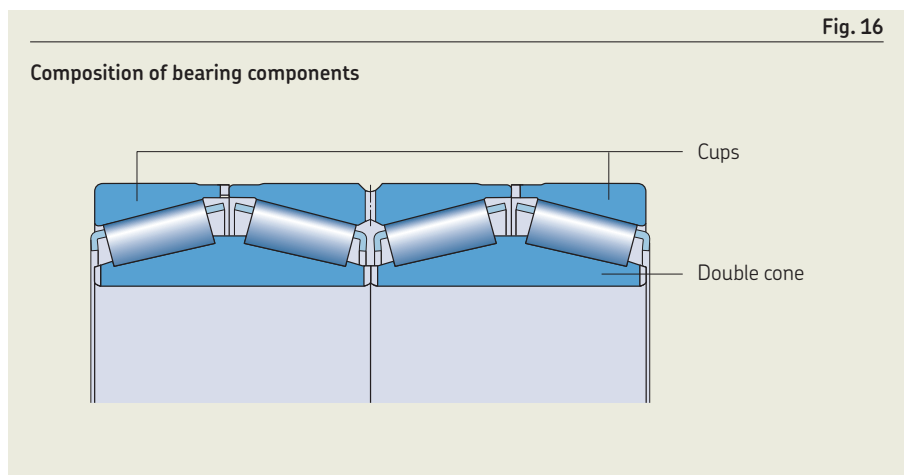

SKF Explorer bearings

SKF continuously expands its assortment of SKF Explorer bearings (page 7). In addition to the existing SKF Explorer tapered roller bearings (product tables, page 694), SKF can also manufacture basic design tapered roller bearings as SKF Explorer bearings, on request. These SKF Explorer tapered roller bearings are identified by the designation suffix PEX.

Cages

SKF single row and matched tapered roller bearings are fitted with one, double row tapered roller bearings are fitted with two of the cages shown in table 3. The standard stamped steel cage is not identified in the bearing designation. If non-standard cages are required, check availability prior to ordering.

When used at high temperatures, some lubricants can have a detrimental effect on polyamide cages. For information about the suitability of cages, refer to Cages, page 187.

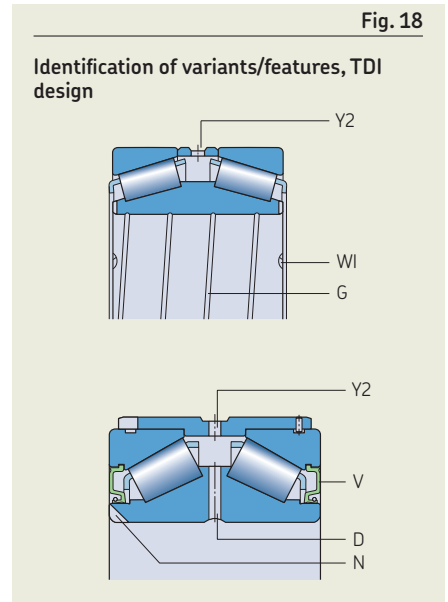
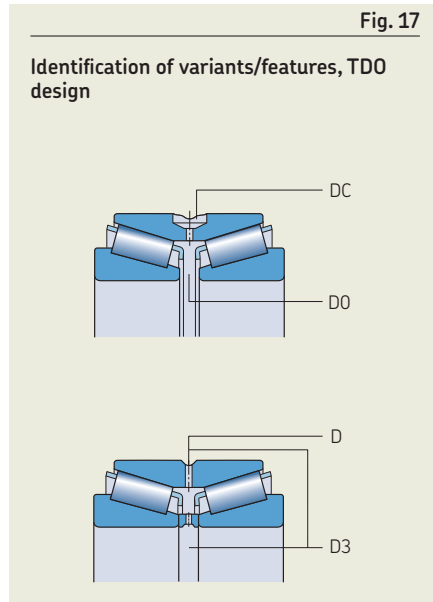

Fig. 18

Fig. 17

Table 3

Cages for tapered roller bearings

Single row and matched bearings

Double row bearings

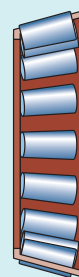
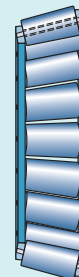
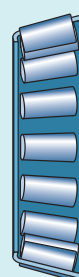
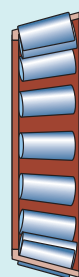
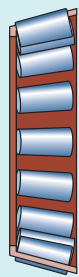
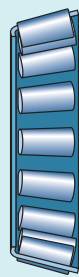

Cage Type	Single row and matched bearings			Double row bearings		
	Window-type, roller centred	Window-type, roller centred	Window-type, roller centred	Window-type, roller centred	Pin-type, pierced rollers	Window-type, roller centred
Material	Stamped steel	PA66, glass fibre reinforced	PEEK, glass fibre reinforced	Stamped steel	Machined steel	PA66, glass fibre reinforced
Suffix	-	TN9	TNH	-	.1	TN9

Bearing data

	Metric single row bearings	Inch single row bearings
Dimension standards	Boundary dimensions: ISO 355 Bearings with designation prefix J: ANSI/ABMA Standard 19.1	Boundary dimensions: AFBMA Standard 19 (ANSI B3.19) ANSI/ABMA Standard 19.2 has replaced the above standard, but does not include dimensions.
Tolerances	<ul style="list-style-type: none"> • Normal • tighter geometrical tolerances for bearings with designation suffix CL7C Bearings with designation prefix J: ANSI/ABMA Standard 19.1 Check availability of tighter width tolerance to 6 X tolerance class (designation suffix CLN) or P5 Values: ISO 492 (table 5, page 41 to table 7, page 43)	Check availability of CL3, CLO or tighter width tolerance Values: ANSI/ABMA Standard 19.2 (table 9, page 45) Deviating width tolerances for cups and cones are identified by a designation suffix (table 4, page 678).
For additional information → page 35	The inner ring with roller and cage assembly (cone) and outer ring (cup) with the same basic designation are interchangeable. The tolerance for the total abutment width T of the bearing is not exceeded if the cones and cups are interchanged.	
Internal clearance	Obtained after mounting, depending on adjustment against a second bearing.	
For additional information → page 182		
Preload	Obtained after mounting, depending on adjustment against a second bearing.	
For additional information → page 182		
Permissible misalignment	SKF Explorer bearings: ≈ 2 to 4 minutes of arc Where misalignment cannot be avoided, SKF recommends using only SKF Explorer bearings. The permissible angular misalignment between the inner and outer rings depends on the size and internal design of the bearing, the radial internal clearance in operation and the forces and moments acting on the bearing. As a result, only approximate values are listed here. Any misalignment increases bearing noise and reduces bearing service life.	

Matched bearings	Double row bearings
Boundary dimensions: ISO 355 (single bearing)	<ul style="list-style-type: none"> metric bearings: not standardized inch bearings: cones and cups dimensions of many inch bearings → AFBMA Standard 19 (ANSI B3.19) ANSI/ABMA Standard 19.2 has replaced the above standard, but does not include dimensions.
<ul style="list-style-type: none"> Normal tighter geometrical tolerances for bearings with designation suffix CL7C check availability of P5 <p>Values: ISO 492 (table 5, page 41, and table 7, page 43)</p> <p>Total width tolerances: not standardized (table 5, page 678)</p>	<ul style="list-style-type: none"> dimensional tolerances (except for width T): Normal geometrical tolerances: P5 <p>Values: ISO 492 (table 5, page 41, table 7, page 43, and table 9, page 45)</p>
<p>Standard (table 6, page 679)</p> <p>Other clearance values are identified by the designation suffix C followed by a three-digit number. For clearance values not listed in the product tables, contact SKF.</p> <p>Values are valid for unmounted bearing sets under measuring loads of:</p> <ul style="list-style-type: none"> $D \leq 90 \text{ mm}$ → 0,1 kN $90 < D \leq 240 \text{ mm}$ → 0,3 kN $D > 240 \text{ mm}$ → 0,5 kN 	<ul style="list-style-type: none"> bearings are ready-to-mount units with an axial internal clearance adapted for the actual application bearing components should be arranged in the prescribed order and may not be interchanged with components of another bearing designations with suffix C followed by a three- or four-digit number expresses mean value of the axial internal clearance in μm (for clearance values not listed in the product tables, contact SKF)
-	
<p>Where misalignment cannot be avoided, SKF recommends using a face-to-face arrangement.</p> <p>Any misalignment increases bearing noise and reduces bearing service life.</p>	<p>If misalignment cannot be avoided, SKF recommends using TDI design bearings (face-to-face arrangement). For information, contact the SKF application engineering service.</p> <p>Any misalignment increases bearing noise and reduces bearing service life.</p>



Table 4

Deviating width tolerances of cups and cones for inch bearings

Designation suffix	Width tolerance ¹⁾	
	$t_{\Delta Ts}$ U	L
–	μm	
/1	+25	0
/1A	+38	+12
/-1	0	-25
/11	+25	-25
/2	+50	0
/2B	+75	+25
/2C	+88	+37
/-2	0	-50
/22	+50	-55
/3	+75	0
/-3	0	-75
/4	+100	0

¹⁾ The total width tolerance for a complete bearing is equal to the sum of the tolerances for the cup and cone.

Table 5

Total width tolerances of matched metric single row tapered roller bearings

Bore diameter d	Total width tolerance Δ_{TsD} of matched bearings in the series																
	329		320		330		331		302, 322		332		303, 323		313		
	Δ_{TsD} U	L	Δ_{TsD} U	L	Δ_{TsD} U	L	Δ_{TsD} U	L	Δ_{TsD} U	L	Δ_{TsD} U	L	Δ_{TsD} U	L	Δ_{TsD} U	L	
mm	μm																
–	30	–	–	+550	+50	–	–	–	–	+550	+100	+550	+100	+600	+100	+500	+50
30	40	+600	+150	+550	+100	–	–	+600	+100	+600	+100	+600	+100	+600	+100	+550	+50
40	50	+650	+150	+600	+100	+650	+150	+600	+100	+600	+100	+600	+100	+600	+150	+550	+50
50	65	+650	+200	+600	+100	+650	+200	+600	+150	+600	+150	+600	+150	+650	+150	+550	+100
65	80	+700	+200	+600	+150	+700	+250	+650	+150	+650	+150	+650	+150	+700	+200	+600	+100
80	100	+750	-150	+650	-250	+800	-50	+700	-200	+700	-200	+700	-200	+700	-200	+600	-300
100	120	+750	-150	+700	-200	+800	-100	+700	-200	+700	-200	+700	-200	+750	-150	+600	-300
120	140	+1 100	-200	+1 000	-300	+1 100	-200	–	–	+1 000	-300	–	–	+1 100	-200	+950	-350
140	160	+1 150	-150	+1 050	-250	+1 100	-200	–	–	+1 050	-250	–	–	+1 150	-150	+950	-350
160	180	+1 150	-150	+1 100	-200	–	–	–	–	+1 100	-200	–	–	+1 150	-150	–	–
180	190	+1 150	-150	+1 100	-200	–	–	–	–	+1 100	-200	–	–	+1 200	-100	–	–
190	200	+1 150	-150	+1 100	-200	–	–	–	–	+1 100	-200	–	–	+1 200	-100	–	–
200	225	+1 200	-100	+1 150	-150	–	–	–	–	+1 150	-150	–	–	+1 250	-50	–	–
225	250	+1 200	-100	+1 200	-100	–	–	–	–	+1 200	-100	–	–	+1 300	0	–	–
250	280	+1 300	0	+1 250	-50	–	–	–	–	+1 250	-50	–	–	–	–	–	–
280	300	+1 400	+100	+1 300	0	–	–	–	–	+1 300	0	–	–	–	–	–	–
300	315	+1 400	+100	+1 350	+50	–	–	–	–	+1 350	+50	–	–	–	–	–	–
315	340	+1 500	-200	+1 450	-250	–	–	–	–	+1 450	-250	–	–	–	–	–	–

Δ_{TsD} designates the deviation of a single total abutment width of a matched bearing set from the nominal.

Table 6

Axial internal clearance of matched metric single row tapered roller bearings, arranged face-to-face or back-to-back

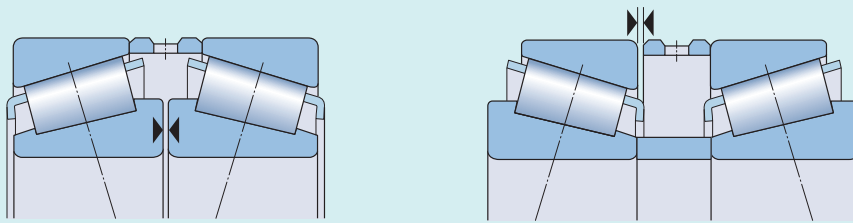

Bore diameter d		Axial internal clearance of matched bearings in the series															
		329		320		330		331		302, 322		332		303, 323		313	
>	≤	min.	max.	min.	max.	min.	max.	min.	max.	min.	max.	min.	max.	min.	max.	min.	max.
mm		μm															
-	30	-	-	80	120	-	-	-	-	100	140	110	150	130	170	60	100
30	40	160	200	100	140	-	-	120	160	120	160	130	170	140	180	70	110
40	50	180	220	120	160	180	220	140	180	140	180	130	170	160	200	80	120
50	65	210	250	140	180	200	240	160	200	160	200	150	190	180	220	100	140
65	80	230	270	160	200	250	290	180	240	180	220	180	220	200	260	110	170
80	100	270	310	190	230	350	390	210	270	210	270	200	260	240	300	110	170
100	120	270	330	220	280	340	400	240	300	220	280	240	300	280	340	130	190
120	140	310	370	240	300	340	400	-	-	240	300	-	-	330	390	160	220
140	160	370	430	270	330	340	400	-	-	270	330	-	-	370	430	180	240
160	180	370	430	310	370	-	-	-	-	310	370	-	-	390	450	-	-
180	190	370	430	340	400	-	-	-	-	340	400	-	-	440	500	-	-
190	200	390	450	340	400	-	-	-	-	340	400	-	-	440	500	-	-
200	225	440	500	390	450	-	-	-	-	390	450	-	-	490	550	-	-
225	250	440	500	440	500	-	-	-	-	440	500	-	-	540	600	-	-
250	280	540	600	490	550	-	-	-	-	490	550	-	-	-	-	-	-
280	300	640	700	540	600	-	-	-	-	540	600	-	-	-	-	-	-
300	340	640	700	590	650	-	-	-	-	590	650	-	-	-	-	-	-

Loads

	Single row bearings	Matched bearings	Double row bearings
Minimum load For additional information → page 106	$F_{rm} = 0,02 C$ Except for SKF Explorer bearings: $F_{rm} = 0,017 C$		
Equivalent dynamic bearing load For additional information → page 91	$F_a/F_r \leq e \rightarrow P = F_r$ $F_a/F_r > e \rightarrow P = 0,4 F_r + Y F_a^{1)}$	Face-to-face or back-to-back arrangement $F_a/F_r \leq e \rightarrow P = F_r + Y_1 F_a$ $F_a/F_r > e \rightarrow P = 0,67 F_r + Y_2 F_a$ Tandem arrangement¹⁾ $F_a/F_r \leq e \rightarrow P = F_r$ $F_a/F_r > e \rightarrow P = 0,4 F_r + Y F_a$	$F_a/F_r \leq e \rightarrow P = F_r + Y_1 F_a$ $F_a/F_r > e \rightarrow P = 0,67 F_r + Y_2 F_a$
Equivalent static bearing load For additional information → page 105	$P_0 = 0,5 F_r + Y_0 F_a^{1)}$ $P_0 < F_r \rightarrow P_0 = F_r$	Face-to-face or back-to-back arrangement $P_0 = F_r + Y_0 F_a$ $P_0 < F_r \rightarrow P_0 = F_r$ Tandem arrangement¹⁾ $P_0 = 0,5 F_r + Y_0 F_a$	$P_0 = F_r + Y_0 F_a$ $P_0 < F_r \rightarrow P_0 = F_r$

Symbols

C	basic dynamic load rating [kN] (product tables, page 694)
e	calculation factor (product tables)
F_a	axial load [kN]
F_r	radial load [kN]
F_{rm}	minimum radial load [kN]
P	equivalent dynamic bearing load [kN]
P_0	equivalent static bearing load [kN]
Y, Y_0, Y_1, Y_2	calculation factors (product tables)

¹⁾ When determining the axial load F_a , refer to *Calculating the axial load for bearings mounted singly or paired in tandem*.

Calculating the axial load for bearings mounted singly or paired in tandem

When a radial load is applied to a single row tapered roller bearing, the load is transmitted from one raceway to the other at an angle to the bearing axis and an internal axial load is induced. This should be considered when calculating the equivalent bearing loads for bearing applications consisting of two single bearing arrangements and/or bearing pairs arranged in tandem.

Necessary equations for various bearing applications and load cases are provided in [table 7, page 682](#). The equations are valid under the following conditions:

- the bearings are adjusted against each other to practically zero clearance, but without any preload
- bearing A is subjected to a radial load F_{rA} and bearing B to a radial load F_{rB}
- both F_{rA} and F_{rB} are always considered positive, even when they act in a direction opposite to that shown in the figures
- the radial loads act at the pressure centres of the bearings (distance a , refer to [product tables, page 694](#))

K_a is the external axial force acting on the shaft or on the housing. Load cases 1c and 2c are also valid when $K_a = 0$.

Values of the calculation factor Y are listed in the product tables.

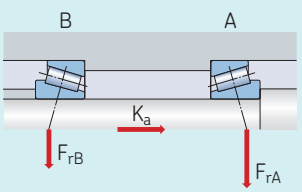
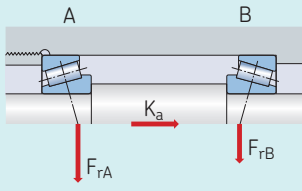
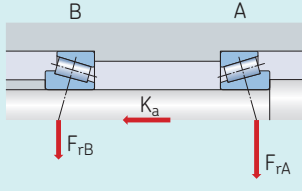
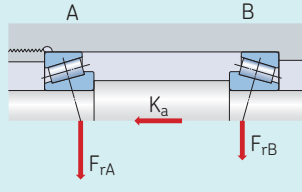

Axial loading of bearing applications incorporating two single row tapered roller bearing arrangements and/or bearing pairs in tandem

Bearing arrangement	Load case	Axial loads	
Back-to-back 	Case 1a $\frac{F_{rA}}{Y_A} \geq \frac{F_{rB}}{Y_B}$ $K_a \geq 0$	$F_{aA} = \frac{0,5 F_{rA}}{Y_A}$	$F_{aB} = F_{aA} + K_a$
Face-to-face 	Case 1b $\frac{F_{rA}}{Y_A} < \frac{F_{rB}}{Y_B}$ $K_a \geq 0,5 \left(\frac{F_{rB}}{Y_B} - \frac{F_{rA}}{Y_A} \right)$	$F_{aA} = \frac{0,5 F_{rA}}{Y_A}$	$F_{aB} = F_{aA} + K_a$
	Case 1c $\frac{F_{rA}}{Y_A} < \frac{F_{rB}}{Y_B}$ $K_a < 0,5 \left(\frac{F_{rB}}{Y_B} - \frac{F_{rA}}{Y_A} \right)$	$F_{aA} = F_{aB} - K_a$	$F_{aB} = \frac{0,5 F_{rB}}{Y_B}$
Back-to-back 	Case 2a $\frac{F_{rA}}{Y_A} \leq \frac{F_{rB}}{Y_B}$ $K_a \geq 0$	$F_{aA} = F_{aB} + K_a$	$F_{aB} = \frac{0,5 F_{rB}}{Y_B}$
Face-to-face 	Case 2b $\frac{F_{rA}}{Y_A} > \frac{F_{rB}}{Y_B}$ $K_a \geq 0,5 \left(\frac{F_{rA}}{Y_A} - \frac{F_{rB}}{Y_B} \right)$	$F_{aA} = F_{aB} + K_a$	$F_{aB} = \frac{0,5 F_{rB}}{Y_B}$
	Case 2c $\frac{F_{rA}}{Y_A} > \frac{F_{rB}}{Y_B}$ $K_a < 0,5 \left(\frac{F_{rA}}{Y_A} - \frac{F_{rB}}{Y_B} \right)$	$F_{aA} = \frac{0,5 F_{rA}}{Y_A}$	$F_{aB} = F_{aA} - K_a$

Calculating the radial load acting on matched bearings

When matched tapered roller bearings, arranged face-to-face or back-to-back, are mounted together with a third bearing, the bearing arrangement is statically indeterminate. In these cases, the radial load F_r acting on the bearing pair must be calculated first.

Matched bearings arranged face-to-face

For matched bearings, where two bearings are arranged face-to-face (fig. 19), it can be assumed that the radial load acts at the geometric centre of the matched bearings, as the distance between the pressure centres of the two bearings is short when compared with the distance between the geometric centres of the set and the other bearing. In this case, it can be assumed that the bearing arrangement is statically determined.

Fig. 19

Matched bearings arranged face-to-face, radial load

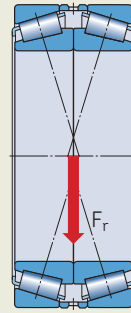

8 Tapered roller bearings

Matched bearings arranged back-to-back

The distance a between the pressure centres of two matched bearings arranged back-to-back is significant when compared with the distance L between the geometric centres of the matched bearings and the other bearing (fig. 20). Therefore, it is necessary to calculate the magnitude of the load acting on the bearing pair and also the distance a_1 at which the load acts. The magnitude of the radial load can be obtained using:

$$F_r = \frac{L_1}{L - a_1} K_r$$

where

F_r = radial load acting on a bearing pair [kN]

K_r = radial force acting on the shaft [kN]

L = distance between the geometric centres of the two bearing positions [mm]

L_1 = distance between the centre of bearing position I and the point of action of the force K_r [mm]

a = distance between the bearing pressure centres [mm] (product table, page 754)

a_1 = distance between the geometric centre of the matched bearings and the point of action of the radial load F_r [mm]

- **diagram 2**

- calculation factor Y_2 , product table

The distance a_1 can be determined from diagram 2 by making an initial assumption for F_r and if necessary followed by several iterative calculations.

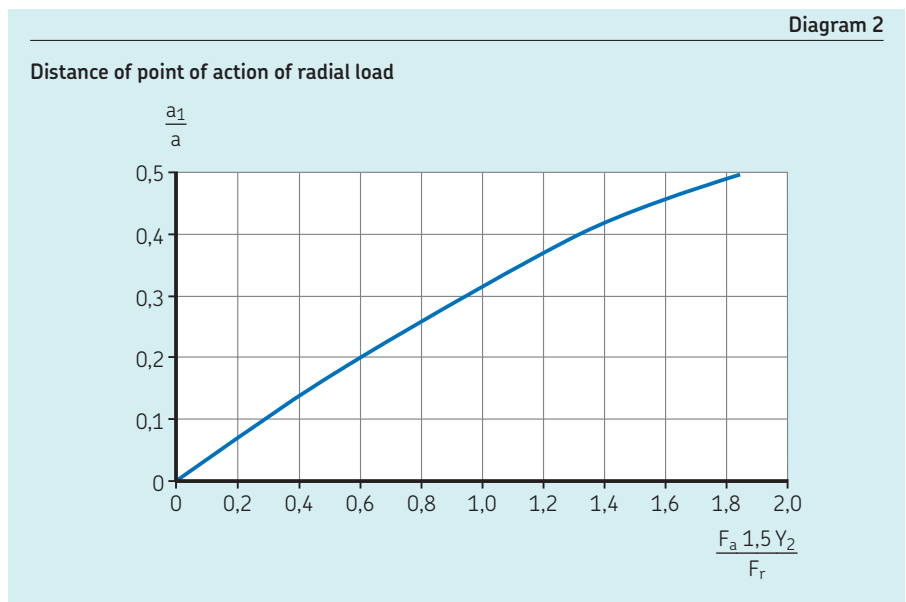
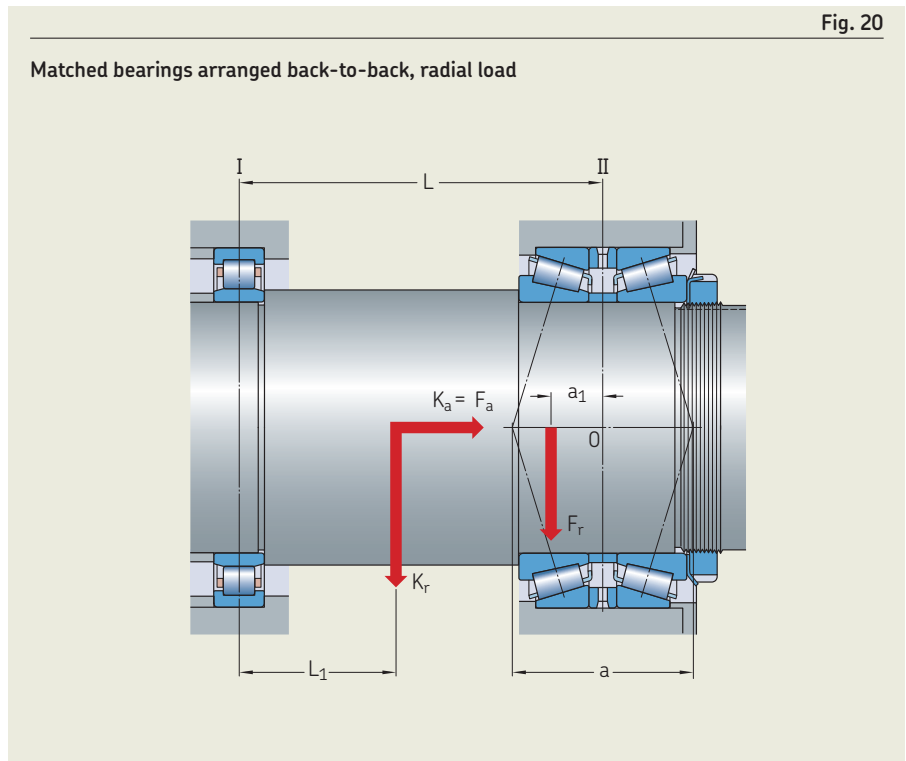

Comparative load ratings for double row tapered roller bearings

For rolling mill applications, load ratings are not necessarily calculated according to ISO 281. Instead, they are often calculated by a different method based on a rating life of 90 million revolutions (500 r/min for 3 000 operating hours). Therefore, for double row tapered roller bearings these comparative load ratings are provided in the product tables because a direct comparison between the comparative and ISO load ratings is not possible, even if the comparative ratings are converted for 1 million revolutions (ISO life definition).

These comparative load ratings may not be used to calculate an ISO rating life. They may only be used together with the comparative rating life and equivalent load equations specified as follows:

$$L_{F10} = 90 \left(\frac{C_F}{P_F} \right)^{10/3}$$

or

$$L_{F10h} = \left(\frac{C_F}{P_F} \right)^{10/3} \left(\frac{1\,500\,000}{n} \right)$$

where

L_{F10} = comparative rating life [million revolutions]

L_{F10h} = comparative rating life [operating hours]

C_F = comparative dynamic load rating to give a rating life of 90 million revolutions [kN] ([product tables](#), [page 762](#))

P_F = comparative equivalent dynamic bearing load [kN] ([table 8](#), [page 686](#))

n = constant rotational speed [r/min]

Temperature limits

The permissible operating temperature for tapered roller bearings can be limited by:

- the dimensional stability of the bearing rings and rollers
- the cages
- the seals
- the lubricant

Where temperatures outside the permissible range are expected, contact SKF.

Bearing rings and rollers

SKF single row and matched tapered roller bearings are heat stabilized up to:

- $D \leq 160$ mm \rightarrow 120 °C (250 °F)
- $D > 160$ mm \rightarrow 150 °C (300 °F)

SKF double row tapered roller bearings are heat stabilized up to 150 °C (300 °F).

Seals

The permissible operating temperature for seals depends on the seal material:

- HNBR: -40 to $+150$ °C (-40 to $+300$ °F)
- FKM: -30 to $+200$ °C (-20 to $+390$ °F)

Typically, temperature peaks are at the seal lip.

Cages

Steel or PEEK cages can be used at the same operating temperatures as the bearing rings and rollers. For temperature limits of cages made of other polymer materials, refer to *Polymer cages*, [page 188](#).

Lubricants

For temperature limits of SKF greases, refer to *Selecting a suitable SKF grease*, [page 116](#).

When using lubricants not supplied by SKF, temperature limits should be evaluated according to the SKF traffic light concept ([page 117](#)).



Permissible speed

The speed ratings in the [product tables](#) indicate:

- the **reference speed**, which enables a quick assessment of the speed capabilities from a thermal frame of reference
- the **limiting speed**, which is a mechanical limit that should not be exceeded unless the bearing design and the application are adapted for higher speeds

For additional information, refer to *Operating temperature and speed*, [page 130](#).

Table 8

Equivalent dynamic bearing load P_F for calculating comparative rating life

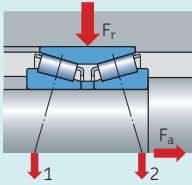
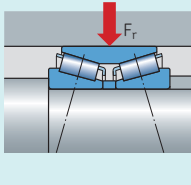
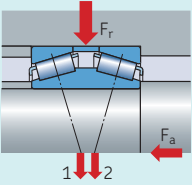
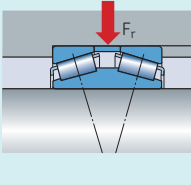
Bearing arrangement	Load case	Comparative equivalent dynamic radial load
 Locating	1a) $F_a \leq 0,6 F_{rL}/K_L$	$P_{FL1} = 0,5 F_{rL} + 0,83 K_L F_a$ $P_{FL2} = 0,5 F_{rL} - 0,83 K_L F_a$ $P_{FN} = F_{rN}$
 Non-locating	1b) $F_a > 0,6 F_{rL}/K_L$	$P_{FL1} = 0,4 F_{rL} + K_L F_a$ $P_{FL2} = 0$ $P_{FN} = F_{rN}$
 Locating	1c) $F_a = 0$	$P_{FL1} = F_{rL}$ $P_{FN} = F_{rN}$
 Non-locating		

Values of the thrust factor K_L are listed as K in the product tables.

For load cases 1a) and 1b), the load rating for one roller row needs to be applied when using P_{FL} . The load rating for one roller row can be obtained from

$$C_{F(row)} = 0,58 C_{F(bearing)}$$

Design considerations

Single row and matched tapered roller bearings

Single row tapered roller bearings must be used either with a second bearing (fig. 21) or as a matched pair (fig. 10, page 670, and fig. 11, page 670). The bearings must be adjusted against each other until the requisite clearance or preload is obtained (*Selecting preload*, page 186).

When the operating clearance in a bearing arrangement is too large, the load carrying capacity of both bearings cannot be fully utilized. Excessive preload increases friction, which increases the amount of frictional heat and reduces bearing service life.

Adjustment procedure

When adjusting tapered roller bearings against each other, the bearings must be rotated so that the rollers assume their correct position, i.e. the large end face of the rollers must be in contact with the guide flange.

Fits

Inch bearings

In contrast to metric bearings, which are machined to a minus tolerance, inch bearings are machined to a plus tolerance (table 9, page 45). Therefore, the deviations for shaft and housing diameters for metric bearings are not applicable. Suitable shaft and housing fits for inch tapered roller bearings are provided in table 9, page 688, and table 10, page 689. These fits are valid for bearings with Normal tolerances in typical applications.

Matched bearings

The axial internal clearance of matched bearings arranged face-to-face or back-to-back (table 6, page 679) provides an appropriate operating clearance when the bearings are mounted on shafts machined to:

- $d \leq 50 \text{ mm}$ → m5[Ⓔ]
- $50 \text{ mm} < d \leq 140 \text{ mm}$ → m6[Ⓔ]
- $140 \text{ mm} < d \leq 200 \text{ mm}$ → n6[Ⓔ]
- $d > 200 \text{ mm}$ → p6[Ⓔ]

SKF recommends these shaft seat tolerance classes for rotating loads on the inner ring where $P \leq 0,06 C$. If tighter fits are selected, be sure that the bearings are not preloaded and are able to rotate freely. The reduction of internal clearance caused by axial locating forces should also be taken into consideration.

For stationary outer ring loads, SKF recommends housing bore tolerance classes J6[Ⓔ] or H7[Ⓔ].

Fig. 21

Single bearings mounted back-to-back

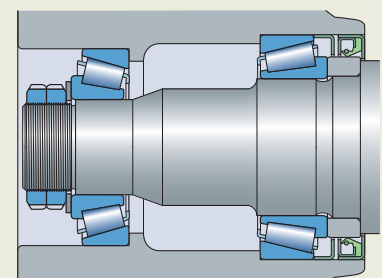

Table 9

Shaft diameter deviations for inch tapered roller bearings with Normal tolerances

Nominal diameter		Deviations for fits clearance/interference in accordance with											
>	≤	f6 [Ⓔ]		g6 [Ⓔ]		h6 [Ⓔ]		j6 [Ⓔ]		k6 [Ⓔ]		m6 [Ⓔ]	
		U	L	U	L	U	L	U	L	U	L	U	L
mm	μm												
10	18	-	-	2	-4	8	2	16	10	20	14	-	-
18	30	-	-	3	-7	10	0	19	9	25	15	-	-
30	50	-	-	3	-12	12	-3	23	8	30	15	-	-
50	76,2	-	-	5	-16	15	-6	27	6	-	-	45	24
80	120	-	-	8	-9	20	3	33	16	-	-	55	38
120	180	-	-	11	-14	25	0	39	14	-	-	65	40
180	250	-	-	15	-19	30	-4	46	12	-	-	-	-
250	304,8	-	-	18	-24	35	-7	51	9	-	-	-	-
315	400	-22	-47	22	-3	40	15	58	33	-	-	-	-
400	500	-23	-57	25	-9	45	11	65	31	-	-	-	-
500	609,6	-26	-69	28	-15	50	7	72	29	-	-	-	-
630	800	-5	-54	51	2	75	26	100	51	-	-	-	-
800	914,4	14	-66	74	6	100	20	128	48	-	-	-	-

Nominal diameter		Deviations for fits clearance/interference in accordance with											
>	≤	n6 [Ⓔ]		p6 [Ⓔ]		r6 [Ⓔ]		r7 [Ⓔ]		r6 [Ⓔ] + IT6		r7 [Ⓔ] + IT7	
		U	L	U	L	U	L	U	L	U	L	U	L
mm	μm												
50	76,2	54	33	-	-	-	-	-	-	-	-	-	-
80	100	65	48	79	62	-	-	-	-	-	-	-	-
100	120	65	48	79	62	-	-	-	-	-	-	-	-
120	140	77	52	93	68	113	88	-	-	-	-	-	-
140	160	77	52	93	68	115	90	-	-	-	-	-	-
160	180	77	52	93	68	118	93	-	-	-	-	-	-
180	200	-	-	109	75	136	102	-	-	-	-	-	-
200	225	-	-	109	75	139	105	-	-	-	-	-	-
225	250	-	-	109	75	143	109	-	-	-	-	-	-
250	280	-	-	123	81	161	119	-	-	-	-	-	-
280	304,8	-	-	-	-	165	123	-	-	-	-	-	-
315	355	-	-	-	-	184	159	-	-	220	195	-	-
355	400	-	-	-	-	190	165	-	-	226	201	-	-
400	450	-	-	-	-	211	177	-	-	251	217	-	-
450	500	-	-	-	-	217	183	-	-	257	223	-	-
500	560	-	-	-	-	-	-	270	201	288	245	340	271
560	609,6	-	-	-	-	-	-	275	206	293	250	345	276
630	710	-	-	-	-	-	-	330	251	350	301	410	331
710	800	-	-	-	-	-	-	340	281	360	311	420	341
800	900	-	-	-	-	-	-	400	286	422	342	490	376

For nominal diameter ranges not listed or higher requirements on accuracy, contact the SKF application engineering service.

Table 10

Housing bore diameter deviations for inch bearings with Normal tolerances

Nominal diameter		Deviations for fits clearance/interference in accordance with									
>	≤	F6 [Ⓔ]		G6 [Ⓔ]		H7 [Ⓔ]		H8 [Ⓔ]		J7 [Ⓔ]	
		U	L	U	L	U	L	U	L	U	L
mm		μm									
30	50	–	–	–	–	36	25	50	25	25	14
50	80	–	–	–	–	43	25	59	25	31	13
80	120	–	–	–	–	50	25	69	25	37	12
120	150	–	–	–	–	58	25	81	25	44	11
150	180	–	–	–	–	65	25	88	25	51	11
180	250	–	–	–	–	76	25	102	25	60	9
250	304,8	–	–	104	42	87	25	116	25	71	9
304,8	315	–	–	104	68	87	51	116	51	71	35
315	400	–	–	115	69	97	51	129	51	79	33
400	500	–	–	128	71	108	51	142	51	88	31
500	609,6	196	127	142	73	120	51	160	51	–	–
609,6	630	196	152	142	98	120	76	160	76	–	–
630	800	235	156	179	100	155	76	200	76	–	–
800	914,4	276	162	216	102	190	76	240	76	–	–
914,4	1 000	276	188	216	128	190	102	240	102	–	–
1 000	1 219,2	328	200	258	130	230	102	290	102	–	–

Nominal diameter		Deviations for fits clearance/interference in accordance with									
>	≤	K7 [Ⓔ]		M7 [Ⓔ]		N7 [Ⓔ]		P7 [Ⓔ]			
		U	L	U	L	U	L	U	L		
mm		μm									
30	50	18	7	11	0	3	–8	–6	–17		
50	80	22	4	13	–5	4	–14	–8	–26		
80	120	25	0	15	–10	5	–20	–9	–34		
120	150	30	–3	18	–15	6	–27	–10	–43		
150	180	37	–3	25	–15	13	–27	–3	–43		
180	250	43	–8	30	–21	16	–35	–3	–54		
250	304,8	51	–11	35	–27	21	–41	–1	–63		
304,8	315	51	15	35	–1	21	–15	–1	–37		
315	400	57	11	40	–6	24	–22	–1	–47		
400	500	63	6	45	–12	28	–29	0	–57		
500	609,6	50	–19	24	–45	6	–63	–28	–97		
609,6	630	50	6	24	–20	6	–38	–28	–72		
630	800	75	–4	45	–34	25	–54	–13	–92		
800	914,4	100	–14	66	–48	44	–70	0	–114		
914,4	1 000	100	12	66	–22	44	–44	0	–88		
1 000	1 219,2	125	–3	85	–43	59	–69	5	–123		

For higher requirements on accuracy, contact the SKF application engineering service.



Mounting

Double row tapered roller bearings

Depending on their design, components of double row tapered roller bearings can also be mounted separately. The individual rings of one bearing must be mounted in the correct order and position. They must also not be mixed with those of another bearing when several bearings are mounted at the same time. Therefore, some precautions have been taken to ease mounting:

- Components of one bearing are marked with letters that indicate their correct order and position (fig. 22).
- All components of one bearing are marked with the same serial number.

Special care should be taken not to deform or compress the relatively thin-walled intermediate rings when mounting smaller TDI design bearings. This can happen, for example, when tightening the cover screws and can have a negative impact on the axial clearance or the preload. Therefore, SKF recommends applying a cover with a centring spigot that is appropriate to the widths of the bearing and the housing seat.

If the knowledge and experience required to mount double row tapered roller bearings is unavailable, especially where large bearings are concerned, SKF recommends that the assistance of SKF service personnel be requested. Further details of the SKF mounting service are available on request.

Load zone

In the majority of rolling mill applications, the direction of a radial load is constant. Depending on the ratio between axial and radial loads, usually only approximately one quarter of the outer ring raceway is under load. Therefore (fig. 23):

- Outer rings are divided into four zones identified by a marking I to IV on the outer ring side faces, on request.
- Markings for zone I are also joined by a line across the outside surface.
- For initial mounting, zone I (line across the outside surface) should be positioned in the direction of the load.
- Depending on the operating conditions, after a period of service the outer rings should be turned through 90° so that a new (the next) zone becomes the loaded zone.

Fig. 22

Components are marked with letters that indicate their correct order and position

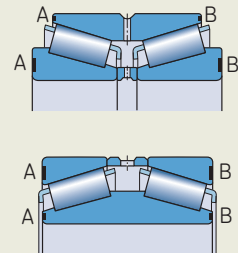
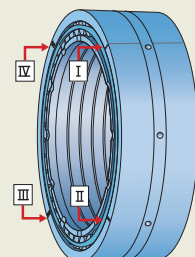

Fig. 23

Side face of the outer ring divided into four zones by a marking I to IV and marking of zone I by a line across the outside surface



Bearing designations

Metric bearings

The designations of metric tapered roller bearings follow one of the following principles:

- The series designations in accordance with ISO 355 consist of a digit and two letters. The digit represents the contact angle. The two letters represent the diameter and width series, respectively. This is followed by a three-digit bore diameter d [mm]. The basic designations of SKF tapered roller bearings start with the letter T, e.g. T2ED 045.
- Designations established prior to 1977 are based on the system shown under *Basic designations*, page 31, e.g. 32206 (table 4, page 30).
- Metric bearings with the designation prefix J follow the ABMA designation system, which is used for inch bearings (ANSI/ABMA Std. 19.1).

Inch bearings

Inch tapered roller bearing designations are in accordance with ANSI/ABMA Std. 19.2.

Within a series:

- roller and cage assemblies are equal but the inner and outer rings can have different sizes and designs
- any inner ring with roller and cage assembly (cone) can be assembled with any outer ring (cup)

General:

- Cup and cone have individual designations and can be supplied separately (fig. 24).
- The designations of cups and cones, as well as the series, consist of a three- to six-digit number, which may be prefixed to characterize a bearing series from extra-light to extra-heavy.
- The complete bearing designation is an abbreviated combination of cone and cup designations. It consists of the cone designation followed by the complete or parts of the cup designation, separated by an oblique stroke (table 11).



Fig. 24

Separately packed components

Table 11

Examples of inch tapered roller bearing designations

Complete bearing	Cone	Cup	Series
LM 11749/710 ¹⁾	LM 11749	LM 11710	LM 11700
JL 26749/710 ¹⁾	JL 26749	JL 26710	L 26700
HM 89449/410 ¹⁾	HM 89449	HM 89410	HM 89400
H 913842/810 ¹⁾	H 913842	H 913810	H 913800
4580/2/4535/2 ²⁾	4580/2	4535/2	4500
9285/9220 ²⁾	9285	9220	9200

¹⁾ Complete bearing designation abbreviated (latest ABMA designations)
²⁾ Complete bearing designation not abbreviated (earlier ABMA designations)

Designation system



Prefixes

- J Metric bearing following the ABMA designation system (ANSI/ABMA Std. 19.2)
- T Metric bearing in accordance with ISO 355

Basic designation

Refer to *Bearing designations*, [page 691](#) or drawing number identification.

- BT2- Drawing number prefixes that may precede a four- or six-digit drawing number
- BT2B

Suffixes

Group 1: Internal design

- A, C, D Deviating or modified internal design, combinations are possible
- B Steep contact angle

Group 2: External design (seals, grooves, etc)

- E SKF Explorer bearing (only for double row bearings)
- G Helical groove in the inner ring bore (only for double row bearings)
- R Flanged outer ring
- T.. A number immediately following the T identifies the total width of matched bearings, arranged back-to-back or in tandem.
- X Boundary dimensions changed to conform to ISO

Group 3: Cage design

- TN9 Glass fibre reinforced PA66 cage, roller centred
- TNH Glass fibre reinforced PEEK cage, roller centred

Group 4.1: Materials, heat treatment

- HA1 Case-hardened inner and outer rings
- HA2 Case-hardened outer ring
- HA3 Case-hardened inner ring
- HA4 Case-hardened inner and outer rings and rollers
- HA5 Case-hardened rollers
- HA6 Case-hardened outer ring(s) and rollers
- HA7 Case-hardened inner ring(s) and rollers
- HB1 Bainite-hardened inner and outer rings
- HB2 Bainite-hardened outer ring(s)
- HN3 Inner ring with special surface heat treatment
- L4B Bearing rings and rollers with special surface coating

Group 4.2: Accuracy, clearance, preload, quiet running

- /1 Deviating width tolerances of cups and cones for inch bearings ([table 4, page 678](#))
- /-1 to /-3 /4
- C... Axial internal clearance (only for double row bearings)
The three- or four-digit number immediately following the C is the mean axial internal clearance in μm .
- CL0 Geometrical tolerances to ABMA tolerance class 0 (inch bearing)
- CL00 Geometrical tolerances to ABMA tolerance class 00 (inch bearing)
- P5 Geometrical tolerances to P5 tolerance class
- U.. U combined with a one- or two-digit number identifies tighter total width tolerance, e.g.:
U2 $\rightarrow +5/0 \mu\text{m}$
U4 $\rightarrow +10/0 \mu\text{m}$
- W Modified ring width tolerance to $+5/0 \mu\text{m}$



Group 4					
4.1	4.2	4.3	4.4	4.5	4.6

Group 4.6: Other variants

CL7A	Pinion bearing, superseded by CL7C
CL7C	High-performance design
CLN	Tighter tolerances for ring widths and total (abutment) width in accordance with ISO tolerance class 6X
PEX	SKF Explorer bearing, used only when same-sized basic design bearing and SKF Explorer bearing are available
V001	CL7C and /2
VA321	Optimized internal design
VA606	Crowned raceway on the outer ring, logarithmic profile on the inner ring and special heat treatment
VA607	Same as VA606, but other outside diameter tolerance
VA901	Contact seal on both sides, outer ring side faces with lubrication grooves, sealing ring between the inner rings
VA902	Contact seal on both sides, without relubrication features, sealing ring between the inner rings
VA903	Contact seal on both sides, outer ring side faces with lubrication grooves, without sealing ring between the inner rings
VA919	Contact seal on both sides, relubrication features in the outer rings, annular groove in the bore and lubrication holes in the inner ring guide flanges
VA941	Contact seal on both sides, inner ring inner side faces with lubrication grooves, inner rings with annular grooves in the bore and lubrication holes in their outer shoulders
VB022	Chamfer dimension of large outer ring side face 0,3 mm
VB026	Chamfer dimension of large inner ring side face 3 mm
VB061	Chamfer dimension of large inner ring side face 8 mm
VB134	Chamfer dimension of large inner ring side face 1 mm
VB406	Chamfer dimension of large inner ring side face 3 mm and of large outer ring side face 2 mm
VB481	Chamfer dimension of large inner ring side face 8,5 mm
VC027	Modified internal geometry for increased permissible misalignment
VC068	Tighter geometrical tolerances and special heat treatment
VE141	One locating slot (notch) in the outer ring
VE174	One locating slot (notch) in the large side face of the outer ring, tighter geometrical tolerances
VQ051	Modified internal geometry for increased permissible misalignment
VQ117	Special radial and axial run-out tolerances
VQ267	Tighter inner ring width tolerance to $\pm 25 \mu\text{m}$
VQ492	Special inner ring width tolerance
VQ494	Tighter radial run-out tolerances
VQ495	CL7C with tighter or shifted tolerance range for the outside diameter
VQ506	Tighter inner ring width tolerance
VQ507	CL7C with tighter or shifted tolerance range for the outside diameter
VQ523	CL7C with tighter inner ring width tolerance and tighter or shifted tolerance range for the outside diameter
VQ601	Geometrical tolerances to ABMA tolerance class 0 (inch bearing)

Group 4.5: Lubrication**Group 4.4: Stabilization****Group 4.3: Bearing sets, matched bearings**

DB..	Two bearings matched for mounting back-to-back. A number immediately following the DB identifies the design of the ring spacers.
DF..	Two bearings matched for mounting face-to-face. A number immediately following the DF identifies the design of the ring spacer.
DT..	Two bearings matched for mounting in tandem. A number immediately following the DT identifies the design of the ring spacers.
C...	Special clearance The two- or three-digit number immediately following the C is the mean axial internal clearance in μm . The range remains the same as specified in table 6, page 679 .

In addition to their designation, double row bearings are also identified by their design variants/features ([product tables, page 762](#)). Some of these features may not be part of the bearing designation, but are always part of the design variants/features ([Variants/features, page 674](#)).



8.1 Metric single row tapered roller bearings

d 15 – 32 mm

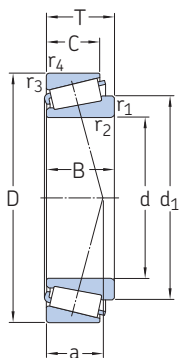

Principal dimensions			Basic load ratings		Fatigue load limit	Speed ratings		Mass	Designation	Dimension series to ISO 355 (ABMA)
d	D	T	C	C ₀	P _u	Reference speed	Limiting speed			
mm			kN		kN	r/min		kg	–	–
15	35	11,75	18,5	14,6	1,43	17 000	20 000	0,055	▶ 30202	2CC
	42	14,25	27,7	20	2,08	15 000	18 000	0,094	▶ 30302	2FB
17	40	13,25	23,4	18,6	1,83	15 000	18 000	0,079	▶ 30203	2DB
	47	15,25	34,2	25	2,7	13 000	16 000	0,13	▶ 30303	2FB
	47	20,25	42,8	33,5	3,65	12 000	16 000	0,17	▶ 32303	2FD
20	42	15	29,7	27	2,65	13 000	16 000	0,099	▶ 32004 X	3CC
	47	15,25	34,1	28	3	12 000	15 000	0,12	▶ 30204	2DB
	52	16,25	41,9	32,5	3,55	12 000	14 000	0,17	▶ 30304	2FB
	52	22,25	54,3	45,5	5	11 000	14 000	0,23	▶ 32304	2FD
22	44	15	30,9	29	2,85	13 000	15 000	0,1	▶ 320/22 X	3CC
25	47	15	33,2	32,5	3,25	12 000	14 000	0,11	▶ 32005 X	4CC
	52	16,25	38,1	33,5	3,45	11 000	13 000	0,15	▶ 30205	3CC
	52	19,25	44,5	44	4,65	10 000	13 000	0,19	▶ 32205 B	5CD
	52	19,25	50,4	45,5	4,9	11 000	13 000	0,19	32205	2CD
	52	22	57,9	56	6	10 000	13 000	0,22	▶ 33205	2CE
	62	18,25	46,6	40	4,4	8 500	11 000	0,27	▶ 31305	7FB
	62	18,25	55,3	43	4,75	9 500	12 000	0,26	▶ 30305	2FB
	62	25,25	74,1	63	7,1	9 000	12 000	0,36	▶ 32305	2FD
28	52	16	39	38	4	10 000	13 000	0,14	▶ 320/28 X	4CC
	58	17,25	46,6	41,5	4,4	10 000	12 000	0,2	▶ 302/28	3DC
	58	20,25	51,9	50	5,5	9 500	12 000	0,25	▶ 322/28 B	5CD
30	55	17	43,9	44	4,55	10 000	12 000	0,17	▶ 32006 X	4CC
	62	17,25	50	44	4,8	9 000	11 000	0,23	▶ 30206	3DB
	62	21,25	61,8	57	6,3	9 000	11 000	0,29	▶ 32206	3DC
	62	25	79,7	76,5	8,5	8 500	11 000	0,35	▶ 33206	2DE
	72	20,75	58,3	50	5,7	7 500	9 500	0,39	▶ 31306	7FB
	72	20,75	69,2	56	6,4	8 000	10 000	0,38	▶ 30306	2FB
	72	28,75	95	85	9,65	7 500	10 000	0,55	▶ 32306	2FD
32	53	14,5	33	35,5	3,65	10 000	12 000	0,12	JL 26749/710	L 26700
	58	17	45,1	46,5	4,8	9 000	11 000	0,19	▶ 320/32 X	4CC

SKF Explorer bearing

▶ Popular item

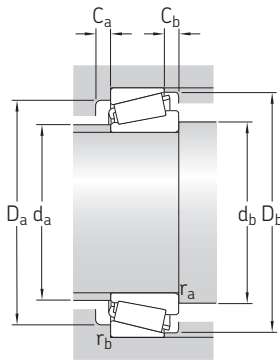

Dimensions							Abutment and fillet dimensions									Calculation factors		
d	d ₁ ≈	B	C	r _{1,2} min.	r _{3,4} min.	a	d _a max.	d _b min.	D _a min.	D _a max.	D _b min.	C _a min.	C _b min.	r _a max.	r _b max.	e	Y	Y ₀
mm							mm									-		
15	25,6	11	9,25	0,6	0,6	8	20	20,5	30	30,5	32	2	2,5	0,6	0,6	0,35	1,7	0,9
	27,8	13	11	1	1	9	22	21,5	36	36,5	38	2	3	1	1	0,28	2,1	1,1
17	29	12	11	1	1	9	23	23,5	34	34,5	37	2	2	1	1	0,35	1,7	0,9
	30,5	14	12	1	1	10	25	23,5	40	41,5	42	2	3	1	1	0,28	2,1	1,1
	30,7	19	16	1	1	12	24	23,5	39	41,5	43	3	4	1	1	0,28	2,1	1,1
20	32,1	15	12	0,6	0,6	10	25	25,5	36	37,5	39	3	3	0,6	0,6	0,37	1,6	0,9
	33,7	14	12	1	1	11	28	26,5	40	41,5	43	2	3	1	1	0,35	1,7	0,9
	34,4	15	13	1,5	1,5	11	28	27,5	44	45,5	47	2	3	1,5	1,5	0,3	2	1,1
	34,6	21	18	1,5	1,5	13	27	27,5	43	45,5	47	3	4	1,5	1,5	0,3	2	1,1
22	34,3	15	11,5	0,6	0,6	10	27	27,5	38	39	41	3	3,5	0,6	0,6	0,4	1,5	0,8
25	37,5	15	11,5	0,6	0,6	11	30	31	40	42	44	3	3,5	0,6	0,6	0,43	1,4	0,8
	38	15	13	1	1	12	32	31,5	44	46	48	2	3	1	1	0,37	1,6	0,9
	41,5	18	15	1	1	15	30	32	41	46,5	50	3	4	1	1	0,57	1,05	0,6
	38,4	18	16	1	1	13	31	32	44	46	50	3	3	1	1	0,35	1,7	0,9
	38,7	22	18	1	1	13	31	32	43	46	49	4	4	1	1	0,35	1,7	0,9
	45,8	17	13	1,5	1,5	19	34	33	47	55	59	3	5	1,5	1,5	0,83	0,72	0,4
	41,5	17	15	1,5	1,5	12	35	33	54	55	57	2	3	1,5	1,5	0,3	2	1,1
	41,7	24	20	1,5	1,5	15	33	33	52	55	57	3	5	1,5	1,5	0,3	2	1,1
28	41,3	16	12	1	1	12	34	35	45	46	49	3	4	1	1	0,43	1,4	0,8
	42	16	14	1	1	13	35	35	50	52	54	2	3	1	1	0,37	1,6	0,9
	43,9	19	16	1	1	16	33	35	46	52	55	3	4	1	1	0,57	1,05	0,6
30	43,6	17	13	1	1	13	36	37	48	49	52	3	4	1	1	0,43	1,4	0,8
	45,3	16	14	1	1	13	38	37	53	56	57	2	3	1	1	0,37	1,6	0,9
	45,2	20	17	1	1	15	37	37	52	56	58	3	4	1	1	0,37	1,6	0,9
	45,8	25	19,5	1	1	15	37	37	53	56	59	4	5,5	1	1	0,35	1,7	0,9
	52,7	19	14	1,5	1,5	22	40	38,5	55	65	68	3	6,5	1,5	1,5	0,83	0,72	0,4
	48,4	19	16	1,5	1,5	14	41	38	62	64	66	3	4,5	1,5	1,5	0,31	1,9	1,1
	48,7	27	23	1,5	1,5	17	39	38	59	65	66	4	5,5	1,5	1,5	0,31	1,9	1,1
32	43,6	15	11,5	3,6	1,3	11	38	44	48	46,5	50	2	3	3,6	1,3	0,33	1,8	1
	46,2	17	13	1	1	13	38	39	50	52	55	3	4	1	1	0,46	1,3	0,7



8.1 Metric single row tapered roller bearings

d 35 – 45 mm

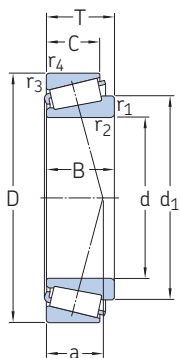

Principal dimensions			Basic load ratings		Fatigue load limit	Speed ratings		Mass	Designation	Dimension series to ISO 355 (ABMA)	
d	D	T	dynamic	static	P_u	Reference speed	Limiting speed				
mm			kN	kN	kN	r/min		kg	—	—	
35	62	18	52,3	54	5,85	8 500	10 000	0,23	▶ 32007 X	4CC	
	72	18,25	63,2	56	6,1	8 000	9 500	0,33	▶ 30207	3DB	
	72	24,25	81,2	78	8,5	8 000	9 500	0,44	▶ 32207	3DC	
	72	28	104	106	11,8	7 000	9 500	0,53	▶ 33207	2DE	
	80	22,75	75,4	67	7,8	6 300	8 500	0,52	▶ 31307	7FB	
	80	22,75	88,9	73,5	8,3	7 500	9 000	0,51	▶ 30307	2FB	
	80	32,75	115	114	12,9	6 300	8 500	0,8	▶ 32307 B	5FE	
	80	32,75	117	106	12,2	6 700	9 000	0,75	▶ 32307	2FE	
	38	63	17	45,7	52	5,4	8 500	10 000	0,2	JL 69349/310	L 69300
		63	17	45,7	52	5,4	8 500	10 000	0,21	JL 69345/310	L 69300
63		17	45,7	52	5,4	8 500	10 000	0,21	JL 69349 A/310	L 69300	
63		17	45,7	52	5,4	8 500	10 000	0,21	JL 69349 X/310	L 69300	
40	68	19	64,7	71	7,65	7 500	9 500	0,28	▶ 32008 X	3CD	
	75	26	97,5	104	11,4	7 000	9 000	0,5	▶ 33108	2CE	
	80	19,75	75,8	68	7,65	7 000	8 500	0,42	▶ 30208	3DB	
	80	24,75	91,6	86,5	9,8	7 000	8 500	0,53	▶ 32208	3DC	
	80	32	128	132	15	6 300	8 500	0,73	▶ 33208	2DE	
	85	33	150	150	17,3	6 700	8 000	0,9	T2EE 040	2EE	
	90	25,25	91,1	81,5	9,5	5 600	7 500	0,72	31308	7FB	
	90	25,25	106	95	10,8	6 300	8 000	0,73	▶ 30308	2FB	
	90	35,25	134	140	16	5 600	7 500	1,1	32308 B	5FD	
	90	35,25	143	140	16	6 000	8 000	1,05	▶ 32308	2FD	
45	75	20	71,7	80	8,8	7 000	8 500	0,34	▶ 32009 X	3CC	
	80	26	104	114	12,9	6 700	8 000	0,55	▶ 33109	3CE	
	85	20,75	81,6	76,5	8,65	6 300	8 000	0,47	▶ 30209	3DB	
	85	24,75	98,7	98	11	6 300	8 000	0,58	▶ 32209	3DC	
	85	32	132	143	16,3	6 000	7 500	0,79	▶ 33209	3DE	
	95	29	110	112	12,7	5 300	7 000	0,93	T7FC 045	7FC	
	95	36	182	186	20,8	6 000	7 000	1,2	▶ T2ED 045	2ED	
	100	27,25	113	102	12,5	5 000	6 700	0,95	31309	7FB	
	100	27,25	132	120	14,3	5 600	7 000	0,97	▶ 30309	2FB	
	100	38,25	166	176	20	5 000	6 700	1,5	32309 B	5FD	
	100	38,25	173	170	20,4	5 300	7 000	1,4	▶ 32309	2FD	

SKF Explorer bearing

▶ Popular item

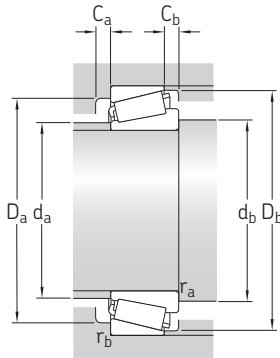

Dimensions							Abutment and fillet dimensions								Calculation factors			
d	d ₁ ≈	B	C	r _{1,2} min.	r _{3,4} min.	a	d _a max.	d _b min.	D _a min.	D _a max.	D _b min.	C _a min.	C _b min.	r _a max.	r _b max.	e	Y	Y ₀
mm							mm								-			
35	49,6	18	14	1	1	14	41	42	54	56	59	4	4	1	1	0,46	1,3	0,7
	51,9	17	15	1,5	1,5	14	44	43,5	62	64	67	3	3	1,5	1,5	0,37	1,6	0,9
	52,4	23	19	1,5	1,5	17	43	43,5	61	64	67	3	5	1,5	1,5	0,37	1,6	0,9
	53,4	28	22	1,5	1,5	18	43	43,5	61	64	68	5	6	1,5	1,5	0,35	1,7	0,9
	59,6	21	15	2	1,5	24	45	44,5	62	72	76	3	7,5	2	1,5	0,83	0,72	0,4
	54,5	21	18	2	1,5	16	46	44,5	70	72	74	3	4,5	2	1,5	0,31	1,9	1,1
	59,3	31	25	2	1,5	24	43	44,5	61	72	76	4	7,5	2	1,5	0,54	1,1	0,6
	54,8	31	25	2	1,5	20	44	44,5	66	72	74	4	7,5	2	1,5	0,31	1,9	1,1
38	52,2	17	13,5	3,6	1,3	14	44	50,5	55	56	60	3	3,5	3,6	1,3	0,43	1,4	0,8
	52,2	19	13,5	3,6	1,3	14	44	50,5	55	56	60	3	3,5	3,6	1,3	0,43	1,4	0,8
	52,2	17	13,5	1,3	1,3	14	44	46	55	56	60	3	3,5	1,3	1,3	0,43	1,4	0,8
	52,2	17	13,5	2,3	1,3	14	44	48	55	56	60	3	3,5	2,3	1,3	0,43	1,4	0,8
40	54,7	19	14,5	1	1	14	46	47,5	60	61	65	4	4,5	1	1	0,37	1,6	0,9
	57,5	26	20,5	1,5	1,5	17	47	48,5	65	67	71	4	5,5	1,5	1,5	0,35	1,7	0,9
	57,5	18	16	1,5	1,5	16	49	48,5	69	72	74	3	3,5	1,5	1,5	0,37	1,6	0,9
	58,4	23	19	1,5	1,5	18	49	48,5	68	72	75	3	5,5	1,5	1,5	0,37	1,6	0,9
	59,7	32	25	1,5	1,5	20	47	48,5	67	72	76	5	7	1,5	1,5	0,35	1,7	0,9
	61,2	32,5	28	2,5	2	21	48	50,5	70	76	80	5	5	2,5	2	0,35	1,7	0,9
	67,1	23	17	2	1,5	28	51	50	71	82	86	3	8	2	1,5	0,83	0,72	0,4
	62,5	23	20	2	1,5	19	53	49,5	77	82	82	3	5	2	1,5	0,35	1,7	0,9
	67,1	33	27	2	1,5	27	50	50	67	82	84	4	8	2	1,5	0,54	1,1	0,6
	62,9	33	27	2	1,5	22	51	49,5	73	82	82	4	8	2	1,5	0,35	1,7	0,9
45	60,7	20	15,5	1	1	16	52	52,5	67	68	72	4	4,5	1	1	0,4	1,5	0,8
	63	26	20,5	1,5	1,5	18	52	53,5	69	72	77	4	5,5	1,5	1,5	0,37	1,6	0,9
	63,1	19	16	1,5	1,5	17	54	53,5	74	77	80	3	4,5	1,5	1,5	0,4	1,5	0,8
	64,1	23	19	1,5	1,5	19	54	53,5	73	77	80	3	5,5	1,5	1,5	0,4	1,5	0,8
	65,3	32	25	1,5	1,5	21	52	53,5	72	77	81	5	7	1,5	1,5	0,4	1,5	0,8
	73,4	26,5	20	2,5	2,5	32	54	56	71	85	91	3	9	2,5	2,5	0,88	0,68	0,4
	68,7	35	30	2,5	2,5	23	55	56	80	85	89	6	6	2,5	2,5	0,33	1,8	1
	74,7	25	18	2	1,5	31	57	55	79	92	95	4	9	2	1,5	0,83	0,72	0,4
	70,2	25	22	2	1,5	20	59	55	86	92	92	3	5	2	1,5	0,35	1,7	0,9
	76,1	36	30	2	1,5	29	56	55	76	92	94	5	8	2	1,5	0,54	1,1	0,6
	71,1	36	30	2	1,5	24	57	55	82	92	93	4	8	2	1,5	0,35	1,7	0,9



8.1 Metric single row tapered roller bearings

d 50 – 55 mm

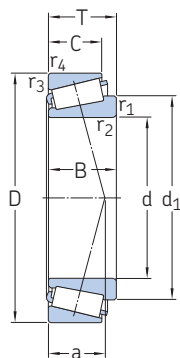

Principal dimensions			Basic load ratings		Fatigue load limit	Speed ratings		Mass	Designation	Dimension series to ISO 355 (ABMA)
d	D	T	C	C ₀	P _u	Reference speed	Limiting speed			
mm			kN		kN	r/min		kg	–	–
50	72	15	41,3	53	5,6	7 000	8 500	0,19	32910	2BC
	80	20	75,1	88	9,65	6 300	8 000	0,38	▶ 32010 X	3CC
	80	24	84,8	102	11,4	6 300	8 000	0,45	▶ 33010	2CE
	82	21,5	88,9	100	11	6 300	8 000	0,43	JLM 104948	LM 104900
	82	21,501	88,9	100	11	6 300	8 000	0,46	AA/910 AA	LM 104900
	85	26	106	122	13,4	6 000	7 500	0,58	▶ 33110	3CE
	90	21,75	93,1	91,5	10,4	6 000	7 500	0,54	▶ 30210	3DB
	90	24,75	101	100	11,4	6 000	7 500	0,62	▶ 32210	3DC
	90	28	130	140	16	6 000	7 500	0,75	JM 205149/110	M 205100
	90	28	130	140	16	6 000	7 500	0,75	JM 205149/110 A	M 205100
	90	32	142	160	18,3	5 300	7 000	0,86	▶ 33210	3DE
	100	36	189	200	22,4	5 600	6 700	1,3	▶ T2ED 050	2ED
	105	32	134	137	16	4 800	6 300	1,25	T7FC 050	7FC
	110	29,25	131	120	14,3	4 500	6 000	1,2	31310	7FB
110	29,25	154	140	16,6	5 300	6 300	1,25	▶ 30310	2FB	
110	42,25	196	216	24,5	4 500	6 000	1,95	32310 B	5FD	
110	42,25	211	212	24	4 800	6 300	1,85	▶ 32310	2FD	
55	80	17	51,7	69,5	7,2	6 300	7 500	0,28	▶ 32911	2BC
	90	23	99,4	116	12,9	5 600	7 000	0,56	▶ 32011 X	3CC
	90	27	111	137	15,3	5 600	7 000	0,66	▶ 33011	2CE
	95	30	136	156	17,6	5 600	6 700	0,85	▶ 33111	3CE
	100	22,75	111	106	12	5 300	6 700	0,7	▶ 30211	3DB
	100	26,75	130	129	15	5 300	6 700	0,84	▶ 32211	3DC
	100	35	170	190	21,6	4 800	6 300	1,15	▶ 33211	3DE
	110	39	220	232	26	5 000	6 000	1,7	T2ED 055	2ED
	115	34	155	163	19,3	4 300	5 600	1,6	T7FC 055	7FC
	120	31,5	149	137	16,6	4 300	5 600	1,55	▶ 31311	7FB
	120	31,5	176	163	19,3	4 800	5 600	1,55	▶ 30311	2FB
	120	45,5	233	260	30	4 300	5 600	2,5	32311 B	5FD
	120	45,5	245	250	28,5	4 300	5 600	2,35	▶ 32311	2FD

SKF Explorer bearing

▶ Popular item

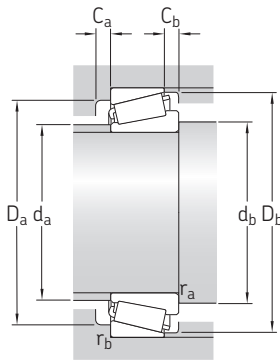

Dimensions							Abutment and fillet dimensions									Calculation factors		
d	d ₁ ≈	B	C	r _{1,2} min.	r _{3,4} min.	a	d _a max.	d _b min.	D _a min.	D _a max.	D _b min.	C _a min.	C _b min.	r _a max.	r _b max.	e	Y	Y ₀
mm							mm									-		
50	62,2	15	12	1	1	13	56	57,5	66	65	69	3	3	1	1	0,35	1,7	0,9
	65,9	20	15,5	1	1	17	57	57,5	72	73	77	4	4,5	1	1	0,43	1,4	0,8
	65,3	24	19	1	1	17	57	57,5	72	73	76	4	5	1	1	0,31	1,9	1,1
	65,1	21,5	17	3,6	1,2	15	57	63	74	75	78	4	4,5	3,6	1,2	0,3	2	1,1
	65,2	27,7	17	3	0,5	15	57	61,5	74	76	78	4	4,5	3	0,5	0,3	2	1,1
	68	26	20	1,5	1,5	20	57	59	74	77	82	4	6	1,5	1,5	0,4	1,5	0,8
	68	20	17	1,5	1,5	19	59	59	79	82	85	3	4,5	1,5	1,5	0,43	1,4	0,8
	68,6	23	19	1,5	1,5	20	58	59	78	82	85	3	5,5	1,5	1,5	0,43	1,4	0,8
	68,8	28	23	3	2,5	20	58	62	78	80	85	5	5	3	2,5	0,33	1,8	1
	68,8	28	23	3	0,8	20	58	62	78	83	85	5	5	3	0,8	0,33	1,8	1
	70,8	32	24,5	1,5	1,5	22	57	59	77	82	87	5	7,5	1,5	1,5	0,4	1,5	0,8
	73,5	35	30	2,5	2,5	24	59	61	84	90	94	6	6	2,5	2,5	0,35	1,7	0,9
	81,3	29	22	3	3	35	60	62	78	94	100	4	10	3	3	0,88	0,68	0,4
	81,5	27	19	2,5	2	33	63	61	87	101	104	4	10	2,5	2	0,83	0,72	0,4
	77,2	27	23	2,5	2	22	66	61	95	101	102	4	6	2,5	2	0,35	1,7	0,9
83,1	40	33	2,5	2	33	62	61,5	83	101	103	5	9	2,5	2	0,54	1,1	0,6	
77,7	40	33	2,5	2	27	63	61	90	101	102	5	9	2,5	2	0,35	1,7	0,9	
55	68,8	17	14	1	1	14	62	62,5	73	73	76	3	3	1	1	0,31	1,9	1,1
	73,3	23	17,5	1,5	1,5	19	63	64	81	82	86	4	5,5	1,5	1,5	0,4	1,5	0,8
	73,1	27	21	1,5	1,5	19	64	64	81	82	86	5	6	1,5	1,5	0,31	1,9	1,1
	75,1	30	23	1,5	1,5	22	63	64	83	87	91	5	7	1,5	1,5	0,37	1,6	0,9
	74,7	21	18	2	1,5	20	64	65	88	92	94	4	4,5	2	1,5	0,4	1,5	0,8
	75,3	25	21	2	1,5	22	64	65	87	92	95	4	5,5	2	1,5	0,4	1,5	0,8
	78,1	35	27	2	1,5	24	63	65	85	92	96	6	8	2	1,5	0,4	1,5	0,8
	80,9	39	32	2,5	2,5	26	65	66	93	100	104	7	7	2,5	2,5	0,35	1,7	0,9
	89,5	31	23,5	3	3	38	66	67,5	86	104	109	4	10,5	3	3	0,88	0,68	0,4
	88,4	29	21	2,5	2	37	68	66,5	94	111	113	4	10,5	2,5	2	0,83	0,72	0,4
	84	29	25	2,5	2	23	72	66,5	104	110	111	4	6,5	2,5	2	0,35	1,7	0,9
	90,5	43	35	2,5	2	36	67	66,5	91	111	112	5	10,5	2,5	2	0,54	1,1	0,6
	84,6	43	35	2,5	2	29	68	66,5	99	110	111	5	10,5	2,5	2	0,35	1,7	0,9



8.1 Metric single row tapered roller bearings

d 60 – 65 mm

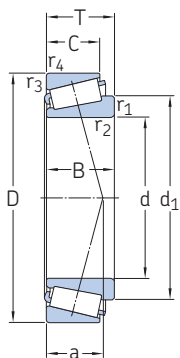

Principal dimensions			Basic load ratings		Fatigue load limit	Speed ratings		Mass	Designation	Dimension series to ISO 355 (ABMA)	
d	D	T	dynamic	static		Reference speed	Limiting speed				
			C	C ₀	P _u						
mm			kN		kN	r/min	kg	–			
60	85	17	53,2	75	7,8	6 000	7 000	0,3	32912	2BC	
	95	23	101	122	13,4	5 300	6 700	0,59	32012 X	4CC	
	95	24	103	132	15	5 300	6 700	0,62	JLM 508748/710	LM 508700	
	95	27	113	143	16	5 300	6 700	0,7	▶ 33012	2CE	
	100	30	144	170	19,6	5 300	6 300	0,92	▶ 33112	3CE	
	110	23,75	120	114	13,2	5 000	6 000	0,88	▶ 30212	3EB	
	110	29,75	155	160	18,6	5 000	6 000	1,15	▶ 32212	3EC	
	110	38	207	236	26,5	4 500	6 000	1,55	▶ 33212	3EE	
	115	40	239	260	30	4 800	5 600	1,85	▶ T2EE 060	2EE	
	125	37	190	204	24,5	4 000	5 300	2,05	T7FC 060	7FC	
	130	33,5	177	166	20,4	3 800	5 300	1,9	▶ 31312	7FB	
	130	33,5	208	196	23,6	4 300	5 300	1,95	▶ 30312	2FB	
	130	48,5	271	305	35,5	3 800	5 000	3,1	32312 B	5FD	
	130	48,5	282	290	34	4 000	5 300	2,9	▶ 32312	2FD	
	65	90	17	54,7	80	8,15	5 600	6 700	0,32	32913	2BC
		100	23	103	127	14	5 000	6 000	0,63	▶ 32013 X	4CC
100		27	119	153	17,3	5 000	6 300	0,75	▶ 33013	2CE	
105		24	122	137	16	5 000	6 000	0,76	JLM 710949/910	LM 710900	
110		28	152	183	21,2	4 800	5 600	1,05	JM 511946/910	M 511900	
110		31	170	193	22,4	4 800	6 000	1,15	▶ T2DD 065	2DD	
110		34	175	208	24	4 800	5 600	1,3	▶ 33113	3DE	
120		24,75	141	134	16,3	4 500	5 600	1,1	▶ 30213	3EB	
120		32,75	186	193	22,8	4 500	5 600	1,5	▶ 32213	3EC	
120		41	239	270	30,5	4 000	5 300	2	▶ 33213	3EE	
130		37	194	216	25,5	3 800	5 000	2,2	T7FC 065	7FC	
140		36	203	193	23,6	3 600	4 800	2,35	31313	7GB	
140		36	240	228	27,5	4 000	4 800	2,4	▶ 30313	2GB	
140		51	305	345	40	3 600	4 800	3,75	32313 B	5GD	
140		51	323	335	40	3 600	4 800	3,5	▶ 32313	2GD	

8.1

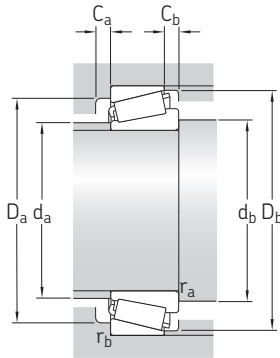

Dimensions							Abutment and fillet dimensions								Calculation factors			
d	d ₁ ≈	B	C	r _{1,2} min.	r _{3,4} min.	a	d _a max.	d _b min.	D _a min.	D _a max.	D _b min.	C _a min.	C _b min.	r _a max.	r _b max.	e	Y	Y ₀
mm							mm								-			
60	73,8	17	14	1	1	15	67	68	78	78	81	3	3	1	1	0,33	1,8	1
	77,8	23	17,5	1,5	1,5	20	67	69	85	87	91	4	5,5	1,5	1,5	0,43	1,4	0,8
	78,5	24	19	5	2,5	20	68	76	84	85	91	4	5	5	2,5	0,4	1,5	0,8
	77,2	27	21	1,5	1,5	19	67	69	85	87	90	5	6	1,5	1,5	0,33	1,8	1
	80,5	30	23	1,5	1,5	23	68	69	88	92	96	5	7	1,5	1,5	0,4	1,5	0,8
	80,9	22	19	2	1,5	21	70	70	96	101	103	3	4,5	2	1,5	0,4	1,5	0,8
	81,9	28	24	2	1,5	24	69	70,5	95	102	104	4	5,5	2	1,5	0,4	1,5	0,8
	85,3	38	29	2	1,5	27	69	70,5	93	102	105	6	9	2	1,5	0,4	1,5	0,8
	85,6	39	33	2,5	2,5	27	70	71,5	98	104	109	6	7	2,5	2,5	0,33	1,8	1
	97,2	33,5	26	3	3	40	72	72,5	94	113	119	4	11	3	3	0,83	0,72	0,4
	96	31	22	3	2,5	39	74	72,5	103	119	123	5	11,5	3	2,5	0,83	0,72	0,4
	91,8	31	26	3	2,5	25	77	72,5	112	119	120	5	7,5	3	2,5	0,35	1,7	0,9
98,6	46	37	3	2,5	38	73	72,5	99	119	122	6	11,5	3	2,5	0,54	1,1	0,6	
91,9	46	37	3	2,5	31	74	72,5	107	119	120	6	11,5	3	2,5	0,35	1,7	0,9	
65	78,8	17	14	1	1	16	71	73	83	83	86	3	3	1	1	0,35	1,7	0,9
	83,3	23	17,5	1,5	1,5	22	73	74	90	92	97	4	5,5	1,5	1,5	0,46	1,3	0,7
	82,6	27	21	1,5	1,5	21	72	74	89	92	96	5	6	1,5	1,5	0,35	1,7	0,9
	84,1	23	18,5	3	1	23	73	77,5	93	97	101	4	5,5	3	1	0,46	1,3	0,7
	87,9	28	22,5	3	2,5	23	75	77,5	96	99	104	5	5,5	3	2,5	0,4	1,5	0,8
	85,7	31	25	2	2	23	74	75,5	97	100	105	5	6	2	2	0,33	1,8	1
	88,3	34	26,5	1,5	1,5	25	74	74,5	96	101	106	6	7,5	1,5	1,5	0,4	1,5	0,8
	89	23	20	2	1,5	23	78	75,5	106	111	113	4	4,5	2	1,5	0,4	1,5	0,8
	90,3	31	27	2	1,5	26	76	75,5	104	111	115	4	5,5	2	1,5	0,4	1,5	0,8
	92,5	41	32	2	1,5	29	75	75,5	102	111	115	6	9	2	1,5	0,4	1,5	0,8
	102	33,5	26	3	3	44	77	78	98	118	124	4	11	3	3	0,88	0,68	0,4
	103	33	23	3	2,5	42	80	78	111	129	132	5	13	3	2,5	0,83	0,72	0,4
	98,7	33	28	3	2,5	27	84	78	122	129	130	5	8	3	2,5	0,35	1,7	0,9
	105	48	39	3	2,5	41	79	78	107	129	131	6	12	3	2,5	0,54	1,1	0,6
	99,2	48	39	3	2,5	33	81	78	117	129	130	6	12	3	2,5	0,35	1,7	0,9



8.1 Metric single row tapered roller bearings

d 70 – 75 mm

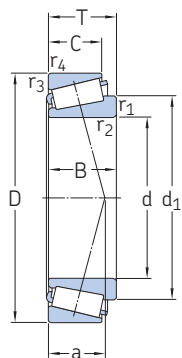

Principal dimensions			Basic load ratings		Fatigue load limit	Speed ratings		Mass	Designation	Dimension series to ISO 355 (ABMA)
d	D	T	dynamic	static		Reference speed	Limiting speed			
mm			kN		kN	r/min		kg	–	–
70	100	20	85,8	112	12,7	5 000	6 000	0,49	32914	2BC
	110	25	125	153	17,3	4 500	5 600	0,85	▶ 32014 X	4CC
	110	31	159	196	22,8	4 800	5 600	1,05	▶ 33014	2CE
	120	37	211	250	28,5	4 300	5 300	1,7	▶ 33114	3DE
	125	26,25	155	156	18	4 300	5 300	1,25	▶ 30214	3EB
	125	33,25	195	208	24,5	4 300	5 300	1,6	▶ 32214	3EC
	125	41	247	285	32,5	3 800	5 000	2,1	▶ 33214	3EE
	130	43	289	325	38	4 000	5 000	2,5	T2ED 070	2ED
	140	39	219	240	27,5	3 400	4 500	2,65	T7FC 070	7FC
	150	38	229	220	27	3 400	4 500	2,85	31314	7GB
75	105	20	86,8	116	13,2	4 800	5 600	0,51	32915	2BC
	115	25	130	163	18,6	4 300	5 300	0,91	▶ 32015 X	4CC
	115	31	167	228	26	4 300	5 300	1,2	▶ 33015	2CE
	120	31	170	216	25	4 300	5 300	1,3	JM 714249/210	M 714200
	125	37	216	265	30	4 000	5 000	1,8	▶ 33115	3DE
	130	27,25	171	176	20,4	4 000	5 000	1,4	▶ 30215	4DB
	130	33,25	197	212	24,5	4 000	5 000	1,65	▶ 32215	4DC
	130	41	255	300	34	3 600	4 800	2,2	▶ 33215	3DE
	145	51	380	450	51	3 600	4 500	3,9	JH 415647/610	H 415600
	145	52	364	450	50	3 600	4 500	3,95	T3FE 075	3FE
150	42	249	280	31	3 200	4 300	3,25	T7FC 075	7FC	
160	40	255	245	29	3 200	4 300	3,4	31315	7GB	
160	40	301	290	34	3 400	4 300	3,5	▶ 30315	2GB	
160	58	410	475	53	3 200	4 000	5,55	▶ 32315 B	5GD	
160	58	416	440	51	3 200	4 300	5,2	▶ 32315	2GD	

8.1



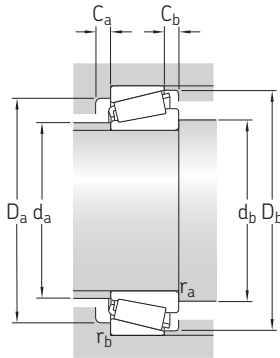

Dimensions							Abutment and fillet dimensions								Calculation factors			
d	d ₁ ≈	B	C	r _{1,2} min.	r _{3,4} min.	a	d _a max.	d _b min.	D _a min.	D _a max.	D _b min.	C _a min.	C _b min.	r _a max.	r _b max.	e	Y	Y ₀
mm							mm								-			
70	84,7	20	16	1	1	17	77	78	93	92	96	4	4	1	1	0,31	1,9	1,1
	89,9	25	19	1,5	1,5	23	78	79,5	98	101	105	5	6	1,5	1,5	0,43	1,4	0,8
	88,9	31	25,5	1,5	1,5	22	78	79,5	99	101	105	5	5,5	1,5	1,5	0,28	2,1	1,1
	95,3	37	29	2	1,5	27	80	80,5	104	111	115	6	8	2	1,5	0,37	1,6	0,9
	94	24	21	2	1,5	25	82	80,5	110	116	118	4	5	2	1,5	0,43	1,4	0,8
	95	31	27	2	1,5	28	81	80,5	108	116	119	4	6	2	1,5	0,43	1,4	0,8
	97,4	41	32	2	1,5	30	80	80,5	107	116	120	6	9	2	1,5	0,4	1,5	0,8
	98,1	42	35	3	2,5	30	81	82,5	111	119	123	7	8	3	2,5	0,33	1,8	1
	110	35,5	27	3	3	46	82	83	106	128	133	5	12	3	3	0,88	0,68	0,4
	111	35	25	3	2,5	45	85	83	118	139	141	5	13	3	2,5	0,83	0,72	0,4
	105	35	30	3	2,5	29	90	83	130	139	140	5	8	3	2,5	0,35	1,7	0,9
	113	51	42	3	2,5	43	85	83	115	139	141	7	12	3	2,5	0,54	1,1	0,6
106	51	42	3	2,5	35	87	83	125	139	140	6	12	3	2,5	0,35	1,7	0,9	
75	89,7	20	16	1	1	18	82	83,5	98	97	101	4	4	1	1	0,33	1,8	1
	95,1	25	19	1,5	1,5	24	83	84,5	103	106	110	5	6	1,5	1,5	0,46	1,3	0,7
	95	31	25,5	1,5	1,5	23	84	84,5	104	106	110	6	5,5	1,5	1,5	0,3	2	1,1
	98,1	29,5	25	3	2,5	28	84	87,5	104	109	115	5	6	3	2,5	0,44	1,35	0,8
	100	37	29	2	1,5	28	84	85,5	109	116	120	6	8	2	1,5	0,4	1,5	0,8
	99,8	25	22	2	1,5	26	87	85,5	115	121	124	4	5	2	1,5	0,43	1,4	0,8
	100	31	27	2	1,5	29	85	85,5	114	121	125	4	6	2	1,5	0,43	1,4	0,8
	102	41	31	2	1,5	31	84	86	111	121	125	6	10	2	1,5	0,43	1,4	0,8
	111	51	42	3	2,5	35	89	88	123	134	139	9	9	3	2,5	0,37	1,6	0,9
	111	51	43	5	3	39	88	92	117	133	138	7	9	5	3	0,43	1,4	0,8
	116	38	29	3	3	50	88	88	114	138	143	5	13	3	3	0,88	0,68	0,4
	118	37	26	3	2,5	48	91	88	127	149	151	5	14	3	2,5	0,83	0,72	0,4
	112	37	31	3	2,5	30	96	88	139	149	149	5	9	3	2,5	0,35	1,7	0,9
	119	55	45	3	2,5	46	89	88	122	149	151	7	13	3	2,5	0,54	1,1	0,6
	113	55	45	3	2,5	37	92	88	133	149	149	7	13	3	2,5	0,35	1,7	0,9



8.1 Metric single row tapered roller bearings

d 80 – 85 mm

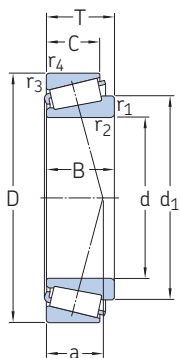

Principal dimensions			Basic load ratings		Fatigue load limit	Speed ratings		Mass	Designation	Dimension series to ISO 355 (ABMA)
d	D	T	C	C ₀	P _u	Reference speed	Limiting speed			
mm			kN		kN	r/min		kg	–	–
80	110	20	89,7	125	14	4 500	5 600	0,54	32916	2BC
	125	29	168	216	24,5	4 000	5 000	1,3	▶ 32016 X	3CC
	125	36	207	285	32	4 000	5 000	1,65	▶ 33016	2CE
	130	35	216	275	31	4 000	4 800	1,75	JM 515649/610	M 515600
	130	37	221	280	31	4 000	4 800	1,85	▶ 33116	3DE
	140	28,25	184	183	21,2	3 800	4 800	1,6	▶ 30216	3EB
	140	35,25	228	245	28,5	3 800	4 500	2,05	▶ 32216	3EC
	140	46	308	375	41,5	3 400	4 500	2,9	▶ 33216	3EE
	160	45	280	315	35,5	3 000	4 000	4	T7FC 080	7FC
	170	42,5	276	265	30,5	3 000	4 000	4,05	31316	7GB
85	120	23	115	156	17,6	4 000	5 000	0,78	32917	2CC
	130	29	171	224	25,5	3 800	4 800	1,35	▶ 32017 X	4CC
	130	30	172	228	26	3 800	4 800	1,4	JM 716649/610	M 716600
	130	36	223	310	34,5	3 800	4 800	1,75	▶ 33017	2CE
	140	41	268	340	38	3 600	4 500	2,45	▶ 33117	3DE
	150	30,5	216	220	25,5	3 600	4 300	2,05	▶ 30217	3EB
	150	38,5	263	285	33,5	3 600	4 300	2,6	▶ 32217	3EC
	150	49	353	430	48	3 200	4 300	3,55	▶ 33217	3EE
	170	48	333	380	43	2 800	3 800	4,85	T7FC 085	7FC
	180	44,5	297	285	32	2 800	3 800	4,6	▶ 31317	7GB
180	44,5	372	365	40,5	3 000	3 800	4,85	▶ 30317	2GB	
180	63,5	417	560	62	3 000	3 600	7,6	32317 B	5GD	
180	63,5	435	530	60	3 000	3 800	7,1	▶ 32317	2GD	

8.1

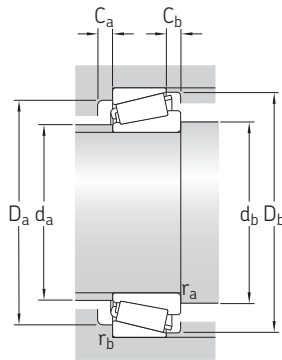

Dimensions							Abutment and fillet dimensions								Calculation factors			
d	d ₁ ≈	B	C	r _{1,2} min.	r _{3,4} min.	a	d _a max.	d _b min.	D _a min.	D _a max.	D _b min.	C _a min.	C _b min.	r _a max.	r _b max.	e	Y	Y ₀
mm							mm								-			
80	94,8	20	16	1	1	19	86	88,5	102	102	106	4	4	1	1	0,35	1,7	0,9
	103	29	22	1,5	1,5	26	90	90	112	116	120	6	7	1,5	1,5	0,43	1,4	0,8
	102	36	29,5	1,5	1,5	25	90	89,5	112	116	119	6	6,5	1,5	1,5	0,28	2,1	1,1
	104	34	28,5	3	2,5	28	90	93	114	119	124	6	6,5	3	2,5	0,4	1,5	0,8
	105	37	29	2	1,5	30	89	91	114	121	126	6	8	2	1,5	0,43	1,4	0,8
	105	26	22	2,5	2	27	92	92	124	130	132	4	6	2,5	2	0,43	1,4	0,8
	106	33	28	2,5	2	30	91	92	122	130	134	5	7	2,5	2	0,43	1,4	0,8
	110	46	35	2,5	2	34	90	92	119	130	135	7	11	2,5	2	0,43	1,4	0,8
	125	41	31	3	3	53	94	93,5	121	148	152	5	14	3	3	0,88	0,68	0,4
	125	39	27	3	2,5	51	97	93,5	134	159	159	5	15,5	3	2,5	0,83	0,72	0,4
122	39	33	3	2,5	33	103	93,5	148	158	159	5	9,5	3	2,5	0,35	1,7	0,9	
128	58	48	3	2,5	49	97	93,5	130	159	160	7	13,5	3	2,5	0,54	1,1	0,6	
120	58	48	3	2,5	40	98	93,5	142	159	159	7	13,5	3	2,5	0,35	1,7	0,9	
85	101	23	18	1,5	1,5	21	93	94,5	111	111	115	4	5	1,5	1,5	0,33	1,8	1
	108	29	22	1,5	1,5	27	95	95	117	121	125	6	7	1,5	1,5	0,44	1,35	0,8
	107	29	24	3	2,5	29	94	98	115	119	125	5	6	3	2,5	0,44	1,35	0,8
	107	36	29,5	1,5	1,5	26	95	95	118	121	125	6	6,5	1,5	1,5	0,3	2	1,1
	112	41	32	2,5	2	32	95	97	122	130	135	7	9	2,5	2	0,4	1,5	0,8
	112	28	24	2,5	2	29	97	97	132	140	141	5	6,5	2,5	2	0,43	1,4	0,8
	113	36	30	2,5	2	33	97	97	130	140	142	5	8,5	2,5	2	0,43	1,4	0,8
	117	49	37	2,5	2	36	96	97	128	140	144	7	12	2,5	2	0,43	1,4	0,8
	132	45	33	4	4	53	100	100	131	156	161	6	15	4	4	0,79	0,76	0,4
	131	41	28	4	3	53	104	100	143	167	169	5	16,5	4	3	0,83	0,72	0,4
	126	41	34	4	3	34	108	100	156	167	167	5	10,5	4	3	0,35	1,7	0,9
	135	60	49	4	3	51	102	100	138	168	169	7	14,5	4	3	0,54	1,1	0,6
	127	60	49	4	3	41	103	100	150	167	167	7	14,5	4	3	0,35	1,7	0,9



8.1 Metric single row tapered roller bearings

d 90 – 100 mm

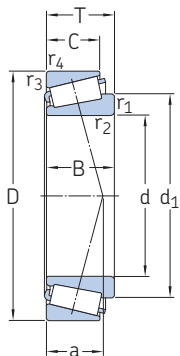

Principal dimensions			Basic load ratings		Fatigue load limit	Speed ratings		Mass	Designation	Dimension series to ISO 355 (ABMA)	
d	D	T	C	C ₀	P _u	Reference speed	Limiting speed				
mm			kN		kN	r/min		kg	–	–	
90	125	23	119	166	18,3	4 000	4 800	0,83	32918	2CC	
	140	32	208	270	31	3 600	4 300	1,75	▶ 32018 X	3CC	
	140	39	266	355	39	3 600	4 500	2,2	▶ 33018	2CE	
	145	35	246	305	33,5	3 600	4 300	2,15	JM 718149 A/110	M 718100	
	145	35	246	305	33,5	3 600	4 300	2,15	JM 718149/110	M 718100	
	150	45	310	390	43	3 400	4 300	3,1	▶ 33118	3DE	
	160	32,5	240	245	28,5	3 400	4 000	2,5	▶ 30218	3FB	
	160	42,5	309	340	38	3 400	4 000	3,35	▶ 32218	3FC	
	160	55	415	520	57	3 000	4 000	4,6	▶ 33218	3FE	
	190	46,5	283	315	35,5	2 400	3 400	5,4	▶ 31318	7GB	
	190	46,5	353	400	44	2 600	3 600	5,65	▶ 30318	2GB	
	190	67,5	487	610	65,5	2 600	3 600	8,4	▶ 32318	2GD	
190	67,5	540	630	69,5	2 800	3 400	8,95	32318 B	5GD		
95	130	23	121	173	18,6	3 800	4 500	0,86	32919	2CC	
	145	32	206	270	30,5	3 400	4 300	1,85	▶ 32019 X	4CC	
	145	39	272	375	40,5	3 400	4 300	2,3	▶ 33019	2CE	
	170	34,5	266	275	31,5	3 200	3 800	3	▶ 30219	3FB	
	170	45,5	348	390	43	3 200	3 800	4,1	▶ 32219	3FC	
	170	58	460	560	62	2 800	3 800	5,45	▶ 33219	3FE	
	200	49,5	314	355	39	2 400	3 400	6,3	▶ 31319	7GB	
	200	49,5	353	390	42,5	2 600	3 400	6,45	30319	2GB	
	200	71,5	535	670	72	2 400	3 400	9,8	▶ 32319	2GD	
	100	140	25	147	204	22,4	3 400	4 300	1,15	▶ 32920	2CC
		145	24	154	190	20,8	3 400	4 300	1,2	▶ T4CB 100	4CB
		150	32	209	280	31	3 200	4 000	1,9	32020 X	4CC
150		39	278	390	41,5	3 400	4 000	2,4	▶ 33020	2CE	
165		47	383	480	52	3 200	3 800	3,9	▶ T2EE 100	2EE	
180		37	304	320	36	3 000	3 600	3,65	▶ 30220	3FB	
180		49	390	440	48	3 000	3 600	4,95	▶ 32220	3FC	
180		63	532	655	71	2 600	3 600	6,75	▶ 33220	3FE	
215		51,5	431	490	53	2 400	3 200	7,95	▶ 30320	2GB	
215		56,5	399	465	51	2 200	3 000	8,6	▶ 31320 X	7GB	
215		77,5	617	780	83	2 200	3 200	12,5	▶ 32320	2GD	

SKF Explorer bearing

▶ Popular item

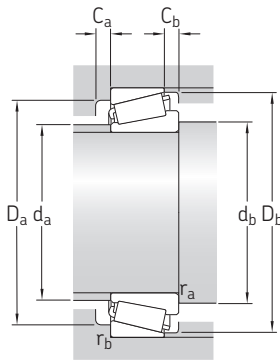

Dimensions							Abutment and fillet dimensions								Calculation factors			
d	d ₁ ≈	B	C	r _{1,2} min.	r _{3,4} min.	a	d _a max.	d _b min.	D _a min.	D _a max.	D _b min.	C _a min.	C _b min.	r _a max.	r _b max.	e	Y	Y ₀
mm							mm								-			
90	106	23	18	1,5	1,5	22	98	100	116	116	120	4	5	1,5	1,5	0,35	1,7	0,9
	115	32	24	2	1,5	29	100	101	125	131	134	6	8	2	1,5	0,43	1,4	0,8
	114	39	32,5	2	1,5	27	101	101	127	131	135	7	6,5	2	1,5	0,27	2,2	1,3
	117	34	27	6	2,5	32	100	109	127	134	139	6	8	6	2,5	0,44	1,35	0,8
	117	34	27	3	2,5	32	100	103	127	134	139	6	8	3	2,5	0,44	1,35	0,8
	120	45	35	2,5	2	34	101	102	130	140	144	7	10	2,5	2	0,4	1,5	0,8
	120	30	26	2,5	2	31	104	102	140	150	150	5	6,5	2,5	2	0,43	1,4	0,8
	121	40	34	2,5	2	35	103	102	138	150	152	5	8,5	2,5	2	0,43	1,4	0,8
	125	55	42	2,5	2	40	101	102	135	150	154	8	13	2,5	2	0,43	1,4	0,8
	138	43	30	4	3	57	110	105	151	177	179	5	16,5	4	3	0,83	0,72	0,4
	133	43	36	4	3	36	114	105	165	177	176	6	10,5	4	3	0,35	1,7	0,9
	133	64	53	4	3	44	109	105	157	177	177	7	14,5	4	3	0,35	1,7	0,9
	141	64	53	4	3	55	107	105	145	177	179	7	14,5	4	3	0,54	1,1	0,6
	95	112	23	18	1,5	1,5	23	103	105	121	121	125	4	5	1,5	1,5	0,35	1,7
120		32	24	2	1,5	31	106	106	130	136	140	6	8	2	1,5	0,44	1,35	0,8
118		39	32,5	2	1,5	28	105	106	131	136	139	7	6,5	2	1,5	0,28	2,1	1,1
126		32	27	3	2,5	32	110	108	149	158	159	5	7,5	3	2,5	0,43	1,4	0,8
128		43	37	3	2,5	38	109	108	145	158	161	5	8,5	3	2,5	0,43	1,4	0,8
132		58	44	3	2,5	42	107	108	144	158	163	9	14	3	2,5	0,4	1,5	0,8
145		45	32	4	3	59	114	111	157	187	187	5	17,5	4	3	0,83	0,72	0,4
139		45	38	4	3	38	119	111	172	187	184	7	11,5	4	3	0,35	1,7	0,9
141		67	55	4	3	47	115	111	166	187	186	8	16,5	4	3	0,35	1,7	0,9
100		119	25	20	1,5	1,5	23	110	110	131	131	135	5	5	1,5	1,5	0,33	1,8
	121	22,5	17,5	3	3	29	109	113	133	133	140	4	6,5	3	3	0,48	1,25	0,7
	125	32	24	2	1,5	32	110	111	134	141	144	6	8	2	1,5	0,46	1,3	0,7
	122	39	32,5	2	1,5	28	109	111	135	141	143	7	6,5	2	1,5	0,28	2,1	1,1
	129	46	39	3	3	35	111	113	145	152	157	7	8	3	3	0,31	1,9	1,1
	134	34	29	3	2,5	35	116	113	157	168	168	5	8	3	2,5	0,43	1,4	0,8
	136	46	39	3	2,5	40	115	113	154	168	171	5	10	3	2,5	0,43	1,4	0,8
	139	63	48	3	2,5	44	112	113	151	168	172	10	15	3	2,5	0,4	1,5	0,8
	149	47	39	4	3	40	128	116	184	202	197	6	12,5	4	3	0,35	1,7	0,9
	158	51	35	4	3	64	121	116	168	202	202	7	21,5	4	3	0,83	0,72	0,4
	152	73	60	4	3	51	123	116	177	202	200	8	17,5	4	3	0,35	1,7	0,9



8.1 Metric single row tapered roller bearings

d 105 – 130 mm

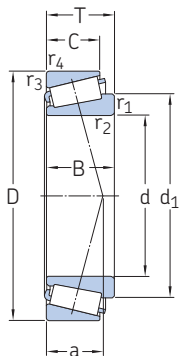

Principal dimensions			Basic load ratings		Fatigue load limit	Speed ratings		Mass	Designation	Dimension series to ISO 355 (ABMA)	
d	D	T	C	C ₀	P _u	Reference speed	Limiting speed				
mm			kN		kN	r/min		kg	–	–	
105	145	25	149	212	22,8	3 400	4 000	1,2	32921	2CC	
	160	35	248	335	37,5	3 200	3 800	2,45	▶ 32021 X	4DC	
	160	43	303	430	45,5	3 200	3 800	3	▶ 33021	2DE	
	190	39	333	355	40	2 800	3 400	4,3	▶ 30221	3FB	
	190	53	443	510	55	2 800	3 400	6	▶ 32221	3FC	
	225	53,5	462	530	57	2 200	3 000	9,1	30321	2GB	
	225	58	429	500	53	2 000	3 000	9,65	31321 X	7GB	
	225	81,5	645	815	85	2 000	3 000	14	▶ 32321	2GD	
	110	150	25	154	224	24	3 200	4 000	1,25	32922	2CC
		165	35	256	355	37,5	3 000	3 600	2,55	JM 822049/010	M 822000
170		38	288	390	40	3 000	3 600	3,05	▶ 32022 X	4DC	
170		47	343	500	53	3 000	3 600	3,85	▶ 33022	2DE	
180		56	455	630	65,5	2 800	3 400	5,5	33122	3EE	
200		41	327	405	43	2 600	3 200	5,05	▶ 30222	3FB	
200		56	491	570	61	2 600	3 200	7,1	▶ 32222	3FC	
240		54,5	507	585	62	2 200	2 800	11	30322	2GB	
240		63	491	585	61	1 900	2 800	12	▶ 31322 X	7GB	
240		84,5	675	830	86,5	1 900	2 800	16,5	▶ 32322	2GD	
120	165	29	204	305	32	3 000	3 600	1,8	▶ 32924	2CC	
	170	27	195	250	26,5	2 800	3 600	1,75	▶ T4CB 120	4CB	
	180	38	299	415	42,5	2 800	3 400	3,3	▶ 32024 X	4DC	
	180	48	356	540	56	2 800	3 400	4,2	▶ 33024	2DE	
	215	43,5	417	465	49	2 400	3 000	6,15	▶ 30224	4FB	
	215	61,5	573	695	72	2 400	3 000	9,05	▶ 32224	4FD	
	260	59,5	601	710	73,5	2 000	2 600	13,5	▶ 30324	2GB	
	260	68	578	695	72	1 700	2 400	15,5	▶ 31324 X	7GB	
	260	90,5	855	1 120	110	1 800	2 600	21,5	▶ 32324	2GD	
	130	180	32	245	365	38	2 600	3 200	2,4	▶ 32926	2CC
200		45	388	540	55	2 400	3 000	4,95	▶ 32026 X	4EC	
200		55	470	680	69,5	2 400	3 000	6,15	33026	2EE	
230		43,75	451	490	51	2 200	2 800	6,85	▶ 30226	4FB	
230		67,75	590	830	85	2 000	2 800	11	▶ 32226	4FD	
280		63,75	679	800	81,5	1 800	2 400	17	▶ 30326	2GB	
280		72	647	780	80	1 600	2 400	18,5	▶ 31326 X	7GB	
280		98,75	1 019	1 340	132	1 600	2 400	27,5	32326	2GD	

SKF Explorer bearing

▶ Popular item

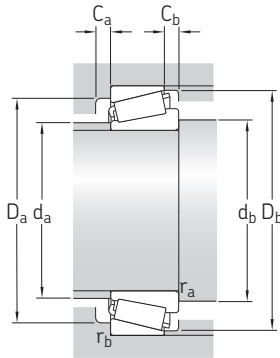

Dimensions							Abutment and fillet dimensions								Calculation factors			
d	d ₁ ≈	B	C	r _{1,2} min.	r _{3,4} min.	a	d _a max.	d _b min.	D _a min.	D _a max.	D _b min.	C _a min.	C _b min.	r _a max.	r _b max.	e	Y	Y ₀
mm							mm								-			
105	124	25	20	1,5	1,5	25	114	115	135	135	140	5	5	1,5	1,5	0,35	1,7	0,9
	132	35	26	2,5	2	34	116	117	143	149	154	6	9	2,5	2	0,44	1,35	0,8
	131	43	34	2,5	2	30	117	117	145	149	153	7	9	2,5	2	0,28	2,1	1,1
	143	36	30	3	2,5	37	123	118	165	178	177	5	9	3	2,5	0,43	1,4	0,8
	143	50	43	3	2,5	44	121	119	161	178	180	6	10	3	2,5	0,43	1,4	0,8
	155	49	41	4	3	41	133	121	193	212	206	7	12,5	4	3	0,35	1,7	0,9
	165	53	36	4	3	67	127	121	176	212	211	7	22	4	3	0,83	0,72	0,4
	158	77	63	4	3	53	129	121	185	212	209	9	18,5	4	3	0,35	1,7	0,9
110	129	25	20	1,5	1,5	26	119	120	140	140	145	5	5	1,5	1,5	0,35	1,7	0,9
	137	35	26,5	3	2,5	37	119	123	145	153	158	6	8,5	3	2,5	0,5	1,2	0,7
	140	38	29	2,5	2	36	123	122	152	159	163	7	9	2,5	2	0,43	1,4	0,8
	139	47	37	2,5	2	33	123	122	152	159	161	7	10	2,5	2	0,28	2,1	1,1
	146	56	43	2,5	2	43	122	123	155	169	174	9	13	2,5	2	0,43	1,4	0,8
	149	38	32	3	2,5	39	129	124	174	188	187	6	9	3	2,5	0,43	1,4	0,8
	151	53	46	3	2,5	46	127	124	170	188	190	6	10	3	2,5	0,43	1,4	0,8
	166	50	42	4	3	42	142	126	206	226	220	8	12,5	4	3	0,35	1,7	0,9
	176	57	38	4	3	72	136	126	188	227	224	8	25	4	3	0,83	0,72	0,4
	169	80	65	4	3	55	138	126	198	227	222	9	19,5	4	3	0,35	1,7	0,9
120	142	29	23	1,5	1,5	28	130	130	154	155	160	5	6	1,5	1,5	0,35	1,7	0,9
	143	25	19,5	3	3	34	131	133	157	157	164	5	7,5	3	3	0,48	1,25	0,7
	150	38	29	2,5	2	38	132	133	161	169	173	7	9	2,5	2	0,46	1,3	0,7
	149	48	38	2,5	2	36	132	133	160	169	171	6	10	2,5	2	0,3	2	1,1
	161	40	34	3	2,5	42	141	134	187	203	201	6	9,5	3	2,5	0,43	1,4	0,8
	164	58	50	3	2,5	51	137	134	181	203	204	7	11,5	3	2,5	0,43	1,4	0,8
	178	55	46	4	3	47	153	136	221	246	237	8	13,5	4	3	0,35	1,7	0,9
	191	62	42	4	3	78	146	136	203	246	244	9	26	4	3	0,83	0,72	0,4
	181	86	69	4	3	59	148	136	213	246	239	10	21,5	4	3	0,35	1,7	0,9
130	153	32	25	2	1,5	31	141	142	167	170	173	6	7	2	1,5	0,33	1,8	1
	165	45	34	2,5	2	42	144	143	178	189	192	7	11	2,5	2	0,43	1,4	0,8
	165	55	43	2,5	2	42	144	143	178	189	192	8	12	2,5	2	0,35	1,7	0,9
	173	40	34	4	3	44	152	146	203	216	217	6	9,5	4	3	0,43	1,4	0,8
	176	64	54	4	3	55	146	146	193	216	219	7	13,5	4	3	0,43	1,4	0,8
	192	58	49	5	4	50	165	149	239	264	255	8	14,5	5	4	0,35	1,7	0,9
	204	66	44	5	4	83	157	149	218	264	261	8	28	5	4	0,83	0,72	0,4
	196	93	78	5	5	65	160	149	230	262	260	10	20,5	5	5	0,35	1,7	0,9



8.1 Metric single row tapered roller bearings

d 140 – 180 mm

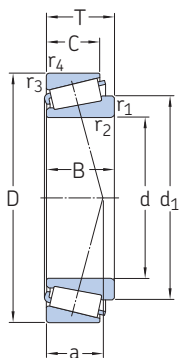

Principal dimensions			Basic load ratings		Fatigue load limit	Speed ratings		Mass	Designation	Dimension series to ISO 355 (ABMA)	
d	D	T	dynamic	static		Reference speed	Limiting speed				
			C	C ₀	P _u						
mm			kN		kN	r/min	kg	–			
140	190	32	252	390	40	2 600	3 000	2,55	▶ 32928	2CC	
	195	29	241	325	33,5	2 400	3 000	2,4	▶ T4CB 140	4CB	
	210	45	404	585	58,5	2 400	2 800	5,25	▶ 32028 X	4DC	
	250	45,75	451	570	58,5	1 900	2 600	8,7	▶ 30228	4FB	
	250	71,75	691	1 000	100	1 900	2 600	14	▶ 32228	4FD	
	300	67,75	787	950	93	1 700	2 200	20,5	30328	2GB	
	300	77	737	900	90	1 500	2 200	22,5	▶ 31328 X	7GB	
	300	107,75	1 220	1 660	156	1 600	2 200	34,5	32328	2GD	
	150	210	32	287	390	40	2 200	2 800	3,1	▶ T4DB 150	4DB
		210	38	346	530	52	2 200	2 800	3,95	32930	2DC
225		48	456	655	65,5	2 200	2 600	6,4	▶ 32030 X	4DC	
225		59	487	865	85	2 200	2 600	8,05	33030	2EE	
270		49	455	560	57	1 800	2 400	10,5	30230	4GB	
270		77	782	1 140	112	1 700	2 400	18	▶ 32230	4GD	
320		72	879	1 060	104	1 600	2 000	25	▶ 30330	2GB	
320		82	832	1 020	100	1 400	2 000	27	▶ 31330 X	7GB	
160		220	32	257	415	41,5	2 200	2 600	3,25	▶ T4DB 160	4DB
		220	38	349	540	53	2 200	2 600	4,2	32932	2DC
	240	51	532	780	76,5	2 000	2 400	7,8	▶ 32032 X	4EC	
	245	61	649	980	96,5	2 000	2 400	10,5	T4EE 160	4EE	
	290	52	566	735	72	1 600	2 200	13	▶ 30232	4GB	
	290	84	934	1 400	132	1 600	2 200	23	▶ 32232	4GD	
	340	75	970	1 180	114	1 500	2 000	29	▶ 30332	2GB	
	170	230	32	307	440	43	2 000	2 600	3,45	▶ T4DB 170	4DB
		230	38	351	585	55	2 000	2 400	4,5	▶ 32934	3DC
		260	57	625	915	88	1 900	2 200	10,5	▶ 32034 X	4EC
310		57	657	865	83	1 500	2 000	16,5	▶ 30234	4GB	
310		91	1 075	1 630	150	1 500	2 000	28,5	▶ 32234	4GD	
360		80	1 103	1 340	129	1 400	1 800	34,5	30334	2GB	
180		240	32	309	450	44	2 000	2 400	3,65	T4DB 180	4DB
		250	45	435	735	68	1 900	2 200	6,65	▶ 32936	4DC
		280	64	793	1 160	110	1 700	2 200	14	▶ 32036 X	3FD
		320	57	629	815	80	1 500	2 000	17	▶ 30236	4GB
	320	91	1 069	1 630	150	1 400	1 900	29,5	▶ 32236	4GD	

SKF Explorer bearing

▶ Popular item

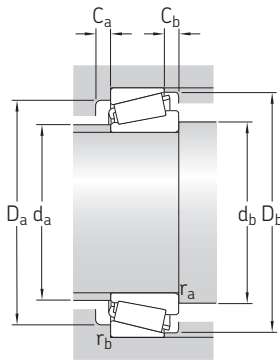

Dimensions							Abutment and fillet dimensions								Calculation factors			
d	d ₁ ≈	B	C	r _{1,2} min.	r _{3,4} min.	a	d _a max.	d _b min.	D _a min.	D _a max.	D _b min.	C _a min.	C _b min.	r _a max.	r _b max.	e	Y	Y ₀
mm							mm								-			
140	164	32	25	2	1,5	33	151	152	177	180	184	6	7	2	1,5	0,35	1,7	0,9
	165	27	21	3	3	40	150	154	180	182	189	6	8	3	3	0,5	1,2	0,7
	175	45	34	2,5	2	45	153	153	187	199	202	8	11	2,5	2	0,46	1,3	0,7
	187	42	36	4	3	47	164	156	219	236	234	8	9,5	4	3	0,43	1,4	0,8
	191	68	58	4	3	59	159	156	210	236	238	8	13,5	4	3	0,43	1,4	0,8
	205	62	53	5	4	54	176	159	255	284	273	8	14,5	5	4	0,35	1,7	0,9
	220	70	47	5	4	90	169	159	235	284	280	9	30	5	4	0,83	0,72	0,4
212	102	85	5	4	71	172	159	247	284	280	12	22,5	5	4	0,35	1,7	0,9	
150	177	30	23	3	3	41	162	164	194	196	203	5	9	3	3	0,46	1,3	0,7
	177	38	30	2,5	2	35	163	163	194	198	202	7	8	2,5	2	0,33	1,8	1
	187	48	36	3	2,5	48	165	164	200	212	216	8	12	3	2,5	0,46	1,3	0,7
	188	59	46	3	2,5	48	165	164	200	212	217	8	13	3	2,5	0,37	1,6	0,9
	200	45	38	4	3	50	176	167	234	256	250	9	11	4	3	0,43	1,4	0,8
	205	73	60	4	3	64	171	167	226	256	254	8	17	4	3	0,43	1,4	0,8
	223	65	55	5	4	58	189	169	273	303	292	9	17	5	4	0,35	1,7	0,9
	234	75	50	5	4	96	181	169	251	304	300	9	32	5	4	0,83	0,72	0,4
160	187	30	23	3	3	44	172	174	204	206	213	5	9	3	3	0,48	1,25	0,7
	188	38	30	2,5	2	38	173	173	204	208	212	7	8	2,5	2	0,35	1,7	0,9
	200	51	38	3	2,5	51	176	175	213	227	231	8	13	3	2,5	0,46	1,3	0,7
	204	59	50	6	4	57	174	181	212	229	236	10	11	6	4	0,44	1,35	0,8
	215	48	40	4	3	53	190	177	252	276	269	7	12	4	3	0,43	1,4	0,8
	222	80	67	4	3	69	183	177	242	276	274	10	17	4	3	0,43	1,4	0,8
	233	68	58	5	4	61	201	179	290	323	310	9	17	5	4	0,35	1,7	0,9
170	197	30	23	3	3	44	182	184	215	216	223	6	9	3	3	0,46	1,3	0,7
	200	38	30	2,5	2	41	183	183	213	218	222	7	8	2,5	2	0,37	1,6	0,9
	214	57	43	3	2,5	55	188	185	230	247	249	10	14	3	2,5	0,44	1,35	0,8
	231	52	43	5	4	58	203	189	269	293	288	8	14	5	4	0,43	1,4	0,8
	238	86	71	5	4	75	196	189	259	293	294	10	20	5	4	0,43	1,4	0,8
	248	72	62	5	4	65	213	190	307	343	329	9	18	5	4	0,35	1,7	0,9
180	207	30	23	3	3	47	191	195	224	226	233	6	9	3	3	0,48	1,25	0,7
	216	45	34	2,5	2	53	194	194	225	238	241	8	11	2,5	2	0,48	1,25	0,7
	230	64	48	3	2,5	59	200	195	247	267	267	10	16	3	2,5	0,43	1,4	0,8
	240	52	43	5	4	60	212	199	278	303	297	8	14	5	4	0,46	1,3	0,7
	247	86	71	5	4	77	205	199	267	303	303	10	20	5	4	0,46	1,3	0,7



8.1 Metric single row tapered roller bearings

d 190 – 360 mm

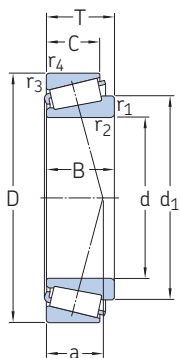

Principal dimensions			Basic load ratings		Fatigue load limit	Speed ratings		Mass	Designation	Dimension series to ISO 355 (ABMA)
d	D	T	dynamic	static		Reference speed	Limiting speed			
			C	C ₀	P _u					
mm			kN		kN	r/min	kg	–		
190	260	45	443	765	72	1 800	2 200	7	▶ 32938 JM 738249/210 ▶ 32038 X	4DC
	260	46	443	765	72	1 800	2 200	7,1		M 738200
	290	64	806	1 200	112	1 600	2 000	15		4FD
	340	60	763	1 000	95	1 400	1 800	20,5	▶ 30238 ▶ 32238	4GB
	340	97	1 267	1 930	176	1 300	1 800	36		4GD
	200	270	37	401	600	57	1 700	2 200	5,45	▶ T4DB 200 ▶ 32940 ▶ 32040 X
280		51	588	950	88	1 700	2 000	9,5	3EC	
310		70	800	1 370	127	1 400	1 900	19	4FD	
360		64	845	1 120	106	1 300	1 700	24,5	▶ 30240 ▶ 32240	4GB
360		104	1 300	2 000	180	1 300	1 700	42,5		3GD
220		285	41	489	830	75	1 600	2 000	6,45	T2DC 220 ▶ 32944 ▶ 32044 X
	300	51	601	1 000	91,5	1 500	1 900	10	3EC	
	340	76	955	1 660	150	1 300	1 700	24,5	4FD	
	400	72	1 059	1 400	127	1 200	1 600	34,5	▶ 30244 ▶ 32244	3GB
	400	114	1 720	2 700	232	1 100	1 500	59,5		4GD
	240	320	42	458	815	73,5	1 400	1 700	8,45	T4EB 240 ▶ 32948 T2EE 240
320		51	624	1 080	96,5	1 400	1 700	11	4EC	
320		57	761	1 320	118	1 400	1 700	12,5	2EE	
360		76	989	1 800	156	1 200	1 600	26,5	▶ 32048 X 30248 32248	4FD
440		79	1 300	1 760	156	1 000	1 400	47		3GB
440		127	1 918	3 350	270	1 000	1 300	81,5		4GD
260	360	63,5	910	1 530	134	1 300	1 600	19	32952	3EC
	400	87	1 241	2 200	190	1 100	1 400	38	▶ 32052 X 32252	4FC
	480	137	2 340	3 650	300	900	1 200	105		4GD
280	380	63,5	950	1 660	143	1 200	1 400	20	32956	4EC
	420	87	1 288	2 360	200	1 000	1 300	40,5	▶ 32056 X 32256	4FC
	500	137	2 410	3 900	310	850	1 200	108		4GD
300	420	76	1 126	2 240	186	950	1 300	31,5	▶ 32960 32060 X 32260	3FD
	460	100	1 644	3 000	245	900	1 200	58		4GD
	540	149	2 935	4 750	365	800	1 100	140		4GD
320	440	76	1 156	2 360	193	900	1 200	33,5	32964	3FD
	480	100	1 663	3 100	250	850	1 100	64	32064 X	4GD
	580	159	3 353	5 500	415	750	1 000	174	32264	4GD
340	460	76	1 163	2 400	196	850	1 200	35	32968	4FD
360	480	76	1 191	2 550	204	800	1 100	37	32972	4FD

SKF Explorer bearing

▶ Popular item

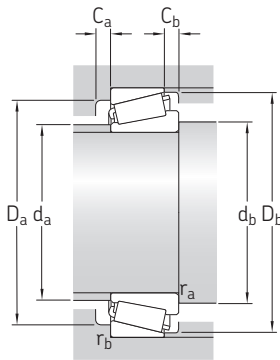

Dimensions							Abutment and fillet dimensions								Calculation factors			
d	d ₁ ≈	B	C	r _{1,2} min.	r _{3,4} min.	a	d _a max.	d _b min.	D _a min.	D _a max.	D _b min.	C _a min.	C _b min.	r _a max.	r _b max.	e	Y	Y ₀
mm							mm								-			
190	227	45	34	2,5	2	54	205	204	235	248	251	8	11	2,5	2	0,48	1,25	0,7
	227	44	36,5	3	2,5	54	205	205	235	247	252	8	9,5	3	2,5	0,48	1,25	0,7
	240	64	48	3	2,5	62	210	205	257	276	279	10	16	3	2,5	0,44	1,35	0,8
	254	55	46	5	4	63	225	210	298	323	318	8	14	5	4	0,43	1,4	0,8
	261	92	75	5	4	80	217	210	286	323	323	12	22	5	4	0,43	1,4	0,8
200	232	34	27	3	3	53	214	215	251	255	262	6	10	3	3	0,48	1,25	0,7
	240	51	39	3	2,5	53	217	215	257	266	271	9	12	3	2,5	0,4	1,5	0,8
	254	70	53	3	2,5	65	222	215	273	296	297	11	17	3	2,5	0,43	1,4	0,8
	269	58	48	5	4	67	237	220	315	343	336	9	16	5	4	0,43	1,4	0,8
	274	98	82	4	4	82	231	218	302	343	340	11	22	4	4	0,4	1,5	0,8
220	249	40	33	4	3	45	233	237	270	270	277	7	8	4	3	0,31	1,9	1,1
	259	51	39	3	2,5	58	235	236	275	286	290	9	12	3	2,5	0,43	1,4	0,8
	280	76	57	4	3	72	244	238	300	325	326	12	19	4	3	0,43	1,4	0,8
	295	65	54	5	4	73	259	240	348	382	371	10	18	5	4	0,43	1,4	0,8
	306	108	90	5	4	95	253	240	334	382	379	13	24	5	4	0,43	1,4	0,8
240	276	39	30	3	3	60	256	256	299	305	310	8	12	3	3	0,46	1,3	0,7
	280	51	39	3	2,5	64	255	256	294	306	311	9	12	3	2,5	0,46	1,3	0,7
	277	56	46	6	4	57	254	262	296	303	311	9	11	6	4	0,35	1,7	0,9
	300	76	57	4	3	77	262	258	318	345	346	12	19	4	3	0,46	1,3	0,7
	324	72	60	4	4	80	285	261	383	420	409	8	19	4	4	0,43	1,4	0,8
	346	120	100	5	4	105	276	262	365	420	415	7	27	4	3	0,43	1,4	0,8
260	308	63,5	48	3	2,5	68	280	276	328	345	347	11	15,5	3	2,5	0,4	1,5	0,8
	328	87	65	5	4	84	288	281	352	382	383	14	22	5	4	0,43	1,4	0,8
	366	130	106	5	5	112	303	286	401	458	454	10	31	5	4	0,43	1,4	0,8
280	329	63,5	48	3	2,5	74	299	297	348	365	368	11	15,5	3	2,5	0,43	1,4	0,8
	348	87	65	5	4	89	306	301	370	402	402	14	22	5	4	0,46	1,3	0,7
	384	130	106	6	5	116	319	302	418	478	473	10	31	5	4	0,44	1,35	0,8
300	359	76	57	4	3	79	325	319	383	404	405	13	19	4	3	0,4	1,5	0,8
	377	100	74	5	4	97	330	322	404	440	439	10	26	4	3	0,43	1,4	0,8
	412	140	115	6	5	126	343	326	453	518	511	10	34	5	4	0,43	1,4	0,8
320	379	76	57	4	3	84	343	337	402	424	426	9	19	3	2,5	0,43	1,4	0,8
	399	100	74	5	4	103	350	342	424	460	461	10	26	4	3	0,46	1,3	0,7
	442	150	125	6	5	133	368	343	486	559	550	12	34	6	5	0,43	1,4	0,8
340	399	76	57	4	3	90	361	357	421	444	446	14	19	3	2,5	0,44	1,35	0,8
360	419	76	57	4	3	96	380	377	439	464	466	10	19	3	2,5	0,46	1,3	0,7



8.2 Inch single row tapered roller bearings

d 15 – 27,487 mm
0.5906 – 1.0822 in.

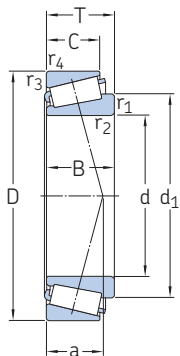

Principal dimensions			Basic load ratings		Fatigue load limit	Speed ratings		Mass	Designation	Series
d	D	T	dynamic	static		Reference speed	Limiting speed			
mm/in.			kN		kN	r/min		kg	–	–
15 0.5906	34,988 1.3775	10,998 0.433	16,5	13,2	1,29	17 000	22 000	0,051	A 4059/A 4138	A 4000
15,875 0.625	42,862 1.6875	14,288 0.5625	21,5	17,6	1,8	13 000	17 000	0,1	11590/11520	11500
17,462 0.6875	39,878 1.57	13,843 0.545	26,1	20,8	2,12	15 000	18 000	0,082	▶ LM 11749/710	LM 11700
19,05 0.75	45,237 1.781	15,494 0.61	33,8	27,5	2,9	13 000	16 000	0,12	▶ LM 11949/910	LM 11900
21,43 0.8437	50,005 1.9687	17,526 0.69	45,4	38	4,15	12 000	15 000	0,17	M 12649/610	M 12600
22 0.8661	45,237 1.781	15,494 0.61	33,9	31	3,2	12 000	15 000	0,12	▶ LM 12749/710	LM 12700
	45,974 1.81	15,494 0.61	33,9	31	3,2	12 000	15 000	0,12	LM 12749/711	LM 12700
22,225 0.875	52,388 2.0625	19,368 0.7625	51,5	44	4,8	11 000	14 000	0,2	1380/1328	1300
25,4 1	50,292 1.98	14,224 0.56	32	30	3	11 000	13 000	0,13	▶ L 44643/610	L 44600
	57,15 2.25	17,462 0.6875	49,1	45,5	4,9	10 000	12 000	0,22	15578/15520	15500
	57,15 2.25	19,431 0.765	48,8	45	5	10 000	12 000	0,24	M 84548/510	M 84500
26,162 1.03	62 2.4409	19,05 0.75	59,5	57	6,2	9 000	11 000	0,3	15101/15245	15000
	61,912 2.4375	19,05 0.75	59,5	57	6,2	9 000	11 000	0,29	15103 S/15243	15000
	62 2.4409	19,05 0.75	59,5	57	6,2	9 000	11 000	0,29	15103 S/15245	15000
26,988 1.0625	50,292 1.98	14,224 0.56	32	30	3	11 000	13 000	0,12	▶ L 44649/610	L 44600
27,487 1.0822	57,159 2.2504	19,845 0.7813	55,6	51	5,6	10 000	12 000	0,23	1982/1924 A	1900

SKF Explorer bearing
▶ Popular item

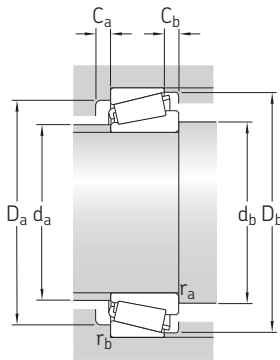

Dimensions			Abutment and fillet dimensions										Calculation factors						
d	d ₁ ≈	B	C	r _{1,2} min.	r _{3,4} min.	a	d _a max.	d _b min.	D _a min.	D _a max.	D _b min.	C _a min.	C _b min.	r _a max.	r _b max.	e	Y	Y ₀	
mm/in.							mm										-		
15 0.5906	25,3	10,988 0.436	8,73 0.3437	0,8 0.03	1,3 0.05	8	20	20,5	28	29	31	2	2	0,8	1,3	0,46	1,3	0,7	
15,875 0.625	31,1	14,288 0.5625	9,525 0.375	1,5 0.06	1,5 0.06	12	23	23,5	32	36,5	38	2	4,5	1,5	1,5	0,72	0,84	0,45	
17,462 0.6875	28,7	14,605 0.575	10,668 0.42	1,3 0.05	1,3 0.05	8	23	24,5	35	34	36	2	3	1,3	1,3	0,28	2,1	1,1	
19,05 0.75	31,4	16,6373 0.655	12,065 0.475	1,3 0.05	1,3 0.05	9	26	26	38	39	41	3	3	1,3	1,3	0,3	2	1,1	
21,43 0.8437	34,6	18,288 0.72	13,97 0.55	1,3 0.05	1,3 0.05	10	28	28,5	43	43,5	46	3	3,5	1,3	1,3	0,28	2,1	1,1	
22 0.8661	34,8	16,637 0.655	12,065 0.475	1,3 0.05	1,3 0.05	10	28	29	39	39	42	3	3	1,3	1,3	0,31	1,9	1,1	
	34,8	16,637 0.655	12,065 0.475	1,3 0.05	1,3 0.05	10	28	29	39	40	42	3	3	1,3	1,3	0,31	1,9	1,1	
22,225 0.875	36	20,168 0.794	14,288 0.5625	1,5 0.06	1,5 0.06	11	29	30	45	45,5	48	4	5	1,5	1,5	0,3	2	1,1	
25,4 1	39,6	14,732 0.58	10,668 0.42	1,3 0.05	1,3 0.05	10	33	32,5	44	44	47	2	3,5	1,3	1,3	0,37	1,6	0,9	
	42,3	17,462 0.6875	13,495 0.5313	1,3 0.05	1,5 0.06	12	35	33	49	50	53	3	3,5	1,3	1,5	0,35	1,7	0,9	
	42,5	19,431 0.765	14,732 0.58	1,5 0.06	1,5 0.06	15	33	33,5	45	50	53	3	4,5	1,5	1,5	0,54	1,1	0,6	
	45,8	20,638 0.8125	14,288 0.5625	0,8 0.03	1,3 0.05	12	38	32	54	55	58	4	4,5	0,8	1,3	0,35	1,7	0,9	
26,162 1.03	45,8	19,939 0.785	14,288 0.5525	0,8 0.03	2 0.08	12	38	33	54	54	58	4	4,5	0,8	2	0,35	1,7	0,9	
	45,8	19,939 0.785	14,288 0.5625	0,8 0.03	1,3 0.05	12	38	33	54	55	58	4	4,5	0,8	1,3	0,35	1,7	0,9	
26,988 1.0625	39,6	14,732 0.58	10,668 0.42	3,5 0.14	1,3 0.05	10	33	38,5	44	44	47	2	3,5	3,5	1,3	0,37	1,6	0,9	
27,487 1.0822	42	19,355 0.762	15,875 0.625	2,5 0.10	0,8 0.03	13	35	37,5	49	51	54	3	3,5	2,5	0,8	0,33	1,8	1	



8.2 Inch single row tapered roller bearings

d 28,575 – 34,925 mm

1.125 – 1.375 in.

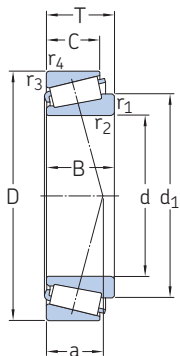

Principal dimensions			Basic load ratings		Fatigue load limit	Speed ratings		Mass	Designation	Series								
d	D	T	dynamic	static		Reference speed	Limiting speed											
mm/in.			kN		kN	r/min		kg	–	–								
28,575 1.125	57,15	19,845	58,2	55	6	10 000	12 000	0,23	1985/1922	1900								
	2.25	0.7813																
	57,15	19,845	58,2	55		6	10 000		12 000	0,23	1988/1922	1900						
	2.25	0.7813																
64,292	21,433	60,4	61	6,8	8 500	11 000	0,35	M 86647/610	M 86600									
2.5312	0.8438																	
29 1.1417	50,292	14,224	31,8		32,5	3,35		11 000	13 000	0,11	▶ L 45449/410	L 45400						
	1.98	0.56																
30,162 1.1875	64,292	21,433	60,4	61	6,8		8 500	11 000	0,34		M 86649/610	M 86600						
	2.5312	0.8438																
	68,262	22,225	67,1	69,5		7,8	8 000	10 000		0,41	M 88043/010	M 88000						
	2.6875	0.875																
31,75 1.25	59,131	15,875	42,8	41,5	4,4		9 500	11 000	0,18		LM 67048/010	LM 67000						
	2.328	0.625																
	61,912	18,161	59,5	57		6,2	9 000	11 000		0,24	15123/15243	15000						
	2.4375	0.715																
	62	18,161	59,5	57			6,2	9 000			11 000	0,24	▶ 15123/15245	15000				
	2.4409	0.715																
73,025	29,37	86,5	95	10,4	7 500			9 000	0,62		HM 88542/510		HM 88500					
2.875	1.1563																	
33,338 1.3125	68,262	22,225	67,1		69,5	7,8		8 000		10 000	0,38		M 88048/010	M 88000				
	2.6875	0.875																
	69,012	19,845	65,8		67		7,35	8 000		10 000		0,35	14131/14276	14000				
2.717	0.7813																	
34,925 1.375	65,088	18,034	58	57	6,2			8 500	10 000	0,25			▶ LM 48548/510	LM 48500				
	2.5625	0.71																
	65,088	18,034	58	57		6,2		8 500	10 000		0,26		▶ LM 48548 A/510	LM 48500				
	2.5625	0.71																
	69,012	19,845	65,8	67			7,35	8 000	10 000			0,34	14137 A/14276	14000				
	2.717	0.7831																
	72,233	25,4	83	90				10	7 500				9 000	0,5	HM 88649 X/610	HM 88600		
	2.8438	1																
	72,233	25,4	83	90					10				7 500		9 000	0,5	HM 88649/610	HM 88600
	2.8438	1																
	73,025	23,812	89,1	88									9,8		8 000		9 500	0,48
2.875	0.9375																	
73,025	26,988	94,6	93	10,4	8 000					9 500					0,53		23690/23620	
2.875	1.0625																	
76,2	29,37	95,2	106		11,8	7 000				8 500	0,66						HM 89446/410	
3	1.1563																	

SKF Explorer bearing

▶ Popular item

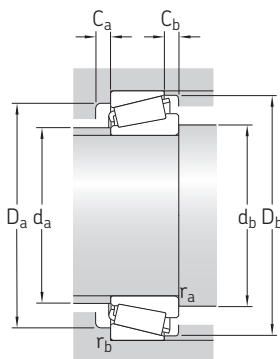

Dimensions				Abutment and fillet dimensions										Calculation factors					
d	d ₁ ≈	B	C	r _{1,2} min.	r _{3,4} min.	a	d _a max.	d _b min.	D _a min.	D _a max.	D _b min.	C _a min.	C _b min.	r _a max.	r _b max.	e	Y	Y ₀	
mm/in.							mm										-		
28,575 1.125	42,1	19,355	15,875	0,8	1,5	13	35	35	49	50	54	3	3,5	0,8	1,5	0,33	1,8	1	
		0,762	0,625	0,03	0,06														
	42	19,355	15,875	3,5	1,5	13	35	40,5	49	50	54	3	3,5	3,5	1,5	0,33	1,8	1	
		0,762	0,625	0,04	0,06														
	50,1	21,433	16,67	1,5	1,5	17	38	36,5	51	57	60	3	4,5	1,5	1,5	0,54	1,1	0,6	
		0,8438	0,6563	0,06	0,06														
29 1.1417	40,7	14,732	10,668	3,5	1,3	10	34	41	45	44	48	3	3,5	3,5	1,3	0,37	1,6	0,9	
		0,58	0,42	0,14	0,05														
30,162 1.1875	50,1	21,433	16,67	1,5	1,5	17	38	38,5	51	57	60	3	4,5	1,5	1,5	0,54	1,1	0,6	
		0,8438	0,6563	0,06	0,06														
	52,3	22,28	17,462	2,4	1,6	18	41	40	54	61	64	3	4,5	2,4	1,6	0,54	1,1	0,6	
		0,8772	0,6875	0,09	0,06														
31,75 1.25	45,6	16,77	11,811	3,6	1,3	12	38	44	51	52	55	3	4	3,6	1,3	0,4	1,5	0,8	
		0,6602	0,465	0,14	0,05														
	45,7	19,05	14,288	3,6	2	12	38	44	54	54	58	4	3,5	3,6	2	0,35	1,7	0,9	
		0,75	0,5625	0,14	0,08														
	45,7	19,05	14,288	3,6	1,3	12	38	44	54	55	58	4	3,5	3,6	1,3	0,35	1,7	0,9	
		0,75	0,5625	0,14	0,05														
	56,9	27,783	23,02	1,2	3,3	23	42	39,5	55	62	69	3	6	1,2	3,3	0,54	1,1	0,6	
		1,0938	0,9063	0,05	0,13														
33,338 1.3125	52,3	22,28	17,462	0,8	1,6	18	41	40	54	61	64	3	4,5	0,8	1,6	0,54	1,1	0,6	
		0,8872	0,6875	0,03	0,06														
	50,7	19,583	15,875	0,8	1,3	15	43	40	57	62	63	3	3,5	0,8	1,3	0,37	1,6	0,9	
		0,771	0,625	0,03	0,05														
34,925 1.375	50	18,288	13,97	3,6	1,3	14	42	47,5	57	58	61	3	4	3,6	1,3	0,37	1,6	0,9	
		0,72	0,55	0,14	0,05														
	50	18,288	13,97	0,8	1,3	14	42	41,5	57	58	61	3	4	0,8	1,3	0,37	1,6	0,9	
		0,72	0,55	0,03	0,05														
	50,7	19,583	15,875	1,5	1,3	15	43	43	57	62	63	3	3,5	1,5	1,3	0,37	1,6	0,9	
		0,771	0,625	0,06	0,05														
	56,6	25,4	19,842	1	2,3	20	42	42,5	57	63	68	5	5,5	1	2,3	0,54	1,1	0,6	
		1	0,7812	0,04	0,09														
	56,6	25,4	19,842	2,3	2,3	20	42	45	57	63	68	5	5,5	2,3	2,3	0,54	1,1	0,6	
		1	0,7812	0,09	0,09														
52,5	24,608	19,05	1,5	0,8	15	44	43	62	67	67	5	4,5	1,5	0,8	0,3	2	1,1		
	0,9688	0,75	0,06	0,03															
52,3	26,975	22,225	3,5	1,5	18	42	47	59	65	67	3	4,5	3,5	1,5	0,37	1,6	0,9		
	1,062	0,875	0,14	0,06															
59,3	28,575	23,02	3,5	3,3	23	44	47,5	58	65	72	3	6	3,5	3,3	0,54	1,1	0,6		
	1,125	0,9063	0,14	0,13															



8.2 Inch single row tapered roller bearings

d 34,987 – 39,688 mm

1.3774 – 1.5625 in.

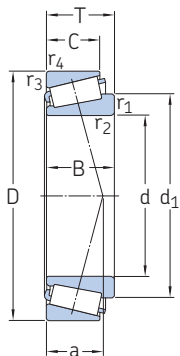

Principal dimensions			Basic load ratings		Fatigue load limit	Speed ratings		Mass	Designation	Series
d	D	T	dynamic	static		Reference speed	Limiting speed			
mm/in.			kN		kN	r/min		kg	–	–
34,987 1.3774	59,131	15,875	40,6	44	4,5	9 000	11 000	0,17	▶ L 68149/110	L 68100
	2,328 59,975	0,625 15,875	40,6	44	4,5	9 000	11 000	0,18	▶ L 68149/111	L 68100
	2,3612	0,625								
35,717 1.4062	72,233	25,4	83	90	10	7 500	9 000	0,49	HM 88648/610	HM 88600
	2,8438	1								
36,487 1.4365	73,025	23,812	89,1	88	9,8	8 000	9 500	0,46	25880/25820	25800
	2,875	0,9375								
36,512 1.4375	76,2	29,37	95,2	106	11,8	7 000	8 500	0,64	HM 89449/410	HM 89400
	3	1.1563								
38,1 1.5	65,088	18,034	53	57	6,1	8 000	10 000	0,23	▶ LM 29748/710	LM 29700
	2,5625	0,71	53	57	6,1	8 000	10 000	0,24	▶ LM 29749/710	LM 29700
	65,088	18,034	53	57	6,1	8 000	10 000	0,25	LM 29749/711	LM 29700
	2,5625	0,71								
	65,088	19,812	53	57	6,1	8 000	10 000	0,25	LM 29749/711	LM 29700
	2,5625	0,78								
	72,238	20,638	60,3	60	6,55	8 000	9 500	0,36	▶ 16150/16284	16000
	2,844	0,8125								
	72,238	23,813	60,3	60	6,55	8 000	9 500	0,39	16150/16283	16000
	2,844	0,9375								
	76,2	23,812	92,1	93	10,4	7 500	9 000	0,5	2788/2720	2700
	3	0,9375								
	79,375	29,37	112	110	12,5	7 000	8 500	0,68	3490/3420	3400
	3,125	1.1563								
	82,55	29,37	106	118	13,4	6 700	8 000	0,77	HM 801346 X/310	HM 801300
	3,25	1.1563								
	82,55	29,37	106	118	13,4	6 700	8 000	0,78	▶ HM 801346/310	HM 801300
	3,25	1.1563								
	82,931	23,812	99,1	106	11,8	6 700	8 000	0,65	▶ 25572/25520	25500
	3,265	0,9375								
	88,5	26,988	123	114	13,2	6 700	8 500	0,83	418/414	415
	3,4843	1.0625								
39,688 1.5625	76,2	23,812	92,1	93	10,4	7 500	9 000	0,48	2789/2729	2700
	3	0,9375								

SKF Explorer bearing

▶ Popular item

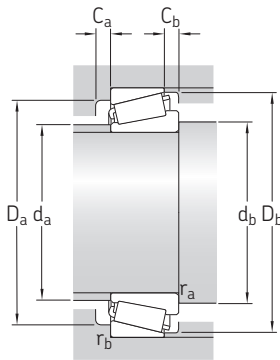

Dimensions			Abutment and fillet dimensions											Calculation factors					
d	d ₁ ≈	B	C	r _{1,2} min.	r _{3,4} min.	a	d _a max.	d _b min.	D _a min.	D _a max.	D _b min.	C _a min.	C _b min.	r _a max.	r _b max.	e	Y	Y ₀	
mm/in.							mm											-	
34,987 1.3774	48,4	16,764	11,938	3,5	1,3	13	41	47	52	52	56	3	3,5	3,5	1,3	0,43	1,4	0,8	
		0,66	0,47	0,14	0,05														
	48,4	16,764	11,938	3,5	1,3	13	41	47	52	53	56	3	3,5	3,5	1,3	0,43	1,4	0,8	
		0,66	0,47	0,14	0,05														
35,717 1.4062	56,6	25,4	19,842	3,5	2,3	20	42	48	57	63	68	5	5,5	3,5	2,3	0,54	1,1	0,6	
		1	0,7812	0,14	0,09														
36,487 1.4365	52,5	24,608	19,05	1,5	2,3	15	44	45	62	64	67	5	4,5	1,5	2,3	0,3	2	1,1	
		0,9688	0,75	0,06	0,09														
36,512 1.4375	59,3	28,575	23,02	3,5	3,3	23	44	49	58	65	72	3	6	3,5	3,3	0,54	1,1	0,6	
		1,125	0,9063	0,14	0,13														
38,1 1.5	52	18,288	13,97	3,6	1,3	13	44	51	58	58	61	3	4	3,6	1,3	0,33	1,8	1	
		0,72	0,55	0,14	0,05														
	51,8	18,288	13,97	2,3	1,3	13	45	48	58	58	61	3	4	2,3	1,3	0,33	1,8	1	
	0,72	0,55	0,09	0,05															
	51,8	18,288	15,748	2,3	1,3	15	45	48	57	58	61	2	4	2,3	1,3	0,33	1,8	1	
	0,72	0,62	0,09	0,05															
	53,8	20,638	15,875	3,5	1,3	16	45	51	60	65	66	3	4,5	3,5	1,3	0,4	1,5	0,8	
		0,8125	0,625	0,14	0,05														
	53,8	20,638	19,05	3,5	2,3	19	45	51	58	63	66	3	4,5	3,5	2,3	0,4	1,5	0,8	
		0,8125	0,75	0,14	0,09														
	54,8	25,654	19,05	3,5	3,3	15	46	51	64	65	69	5	4,5	3,5	3,3	0,3	2	1,1	
		1,01	0,75	0,14	0,13														
	57,3	29,771	23,812	3,5	3,3	20	46	51	65	68	73	4	5,5	3,5	3,3	0,37	1,6	0,9	
		1,1721	0,9375	0,14	0,13														
	64,1	28,575	23,02	2,3	3,3	24	49	48,5	64	71	78	4	6	2,3	3,3	0,54	1,1	0,6	
		1,125	0,9063	0,09	0,13														
	64,1	28,575	23,02	0,8	3,3	24	49	45,5	64	71	78	4	6	0,8	3,3	0,54	1,1	0,6	
		1,125	0,9063	0,03	0,13														
	62,2	25,4	19,05	0,8	0,8	16	53	45,5	71	76	76	5	4,5	0,8	0,8	0,33	1,8	1	
		1	0,75	0,03	0,03														
	58,8	29,083	22,225	3,5	1,5	16	49	51	73	81	78	5	4,5	3,5	1,5	0,26	2,3	1,3	
		1,145	0,875	0,14	0,06														
39,688 1.5625	54,8	25,654	19,05	3,5	0,8	15	46	52	64	70	69	5	4,5	3,5	0,8	0,3	2	1,1	
		1,01	0,75	0,14	0,03														



8.2 Inch single row tapered roller bearings

d 40 – 42,875 mm
1.5748 – 1.688 in.

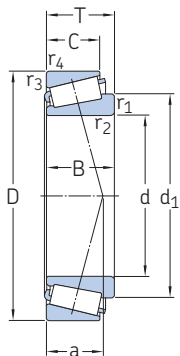

Principal dimensions			Basic load ratings		Fatigue load limit	Speed ratings		Mass	Designation	Series
d	D	T	dynamic	static		Reference speed	Limiting speed			
mm/in.			kN		kN	r/min		kg	–	–
40 1.5748	80	21	87,6	80	9,15	7 000	8 500	0,47	344/332	335
	3.1496	0.8268								
	80	21	87,6	80	9,15	7 000	8 500	0,47	344/332 AA	335
	3.1496	0.8268								
	80	21	87,6	80	9,15	7 000	8 500	0,48	344 A/332	335
	3.1496	0.8268								
41 1.6142	68	17,5	53,6	58,5	6,3	8 000	9 500	0,24	▶ LM 300849/811	LM 300800
	2.6772	0.689								
41,275 1.625	73,025	16,667	57,7	56	6,2	7 500	9 000	0,28	▶ 18590/18520	18500
	2.875	0.6562								
	73,431	19,558	67,6	68	7,65	7 500	9 000	0,34	▶ LM 501349/310	LM 501300
	2.891	0.77								
	73,431	21,43	67,6	68	7,65	7 500	9 000	0,36	▶ LM 501349/314	LM 501300
	2.891	0.8437								
	76,2	18,009	55,7	56	6,1	7 000	9 000	0,34	11162/11300	11000
	3	0.709								
	76,2	18,009	55,7	56	6,1	7 000	9 000	0,34	11163/11300	11000
	3	0.709								
76,2	22,225	84,2	86,5	9,65	7 000	9 000	0,44	▶ 24780/24720	24700	
3	0.875									
	82,55	26,543	91,2	91,5	10,6	6 700	8 000	0,62	M 802048/011	M 802000
	3.25	1.045								
	87,312	30,162	126	132	15	6 300	8 000	0,85	3585/3525	3500
	3.4375	1.1875								
	88,9	30,162	116	127	14,6	6 000	7 500	0,91	HM 803146/110	HM 803100
	3.5	1.1875								
	101,6	34,925	184	190	21,6	5 600	6 700	1,45	526/522	525
	4	1.375								
42,875 1.688	82,931	23,812	99,1	106	11,8	6 700	8 000	0,59	▶ 25577/25520	25500
	3.265	0.9375								
	82,931	26,988	99,1	106	12	6 700	8 000	0,63	25577/25523	25500
	3.265	1.0625								

SKF Explorer bearing
▶ Popular item

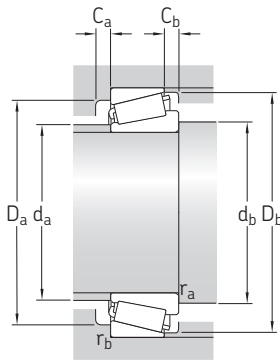

Dimensions			Abutment and fillet dimensions											Calculation factors					
d	d ₁ ≈	B	C	r _{1,2} min.	r _{3,4} min.	a	d _a max.	d _b min.	D _a min.	D _a max.	D _b min.	C _a min.	C _b min.	r _a max.	r _b max.	e	Y	Y ₀	
mm/in.							mm											-	
40 1.5748	57,6	22,403	17,826	3,5	1,3	14	50	53	72	73	75	4	3	3,5	1,3	0,27	2,2	1,3	
		0.882	0.7018	0.14	0.05														
	57,6	22,403	17,826	3,5	0,8	14	50	53	72	74	75	4	3	3,5	0,8	0,27	2,2	1,3	
	0.882	0.7018	0.14	0.03															
	57,6	22,403	17,826	0,8	1,3	14	50	47	72	73	75	4	3	0,8	1,3	0,27	2,2	1,3	
	0.882	0.7018	0.03	0.05															
41 1.6142	55,4	18	13,5	3,6	1,5	13	47	54	61	60	64	3	4	3,6	1,5	0,35	1,7	0,9	
		0.7087	0.5315	0.14	0.06														
41,275 1.625	56,2	17,463	12,7	3,5	1,5	13	50	54	66	65	68	3	3,5	3,5	1,5	0,35	1,7	0,9	
		0.6875	0.5	0.14	0.06														
	57,7	19,812	14,732	3,5	0,8	15	48	54	64	67	69	4	4,5	3,5	0,8	0,4	1,5	0,8	
		0.78	0.58	0.14	0.03														
	57,7	19,812	16,604	3,5	0,8	17	48	54	63	67	69	3	4,5	3,5	0,8	0,4	1,5	0,8	
		0.78	0.6537	0.14	0.03														
	58,2	17,384	14,288	1,5	1,5	16	50	49,5	65	68	71	3	3,5	1,5	1,5	0,48	1,25	0,7	
		0.6844	0.5625	0.06	0.06														
	58,2	17,384	14,288	0,8	1,5	16	50	48,5	65	68	71	3	3,5	0,8	1,5	0,48	1,25	0,7	
		0.6844	0.5625	0.03	0.06														
57,7	23,02	17,462	3,5	0,8	17	49	54	65	70	71	4	4,5	3,5	0,8	0,4	1,5	0,8		
	0.9063	0.6875	0.14	0.03															
	62,3	25,654	20,193	3,5	3,3	22	49	54	66	71	78	4	6	3,5	3,3	0,54	1,1	0,6	
	1.01	0.795	0.14	0.13															
	63,1	30,886	23,812	1,5	3,3	19	53	50	73	76	80	4	6	1,5	3,3	0,31	1,9	1,1	
	1.216	0.9375	0.06	0.13															
	69	29,37	23,02	3,5	3,3	25	53	54	70	77	84	4	7	3,5	3,3	0,54	1,1	0,6	
	1.1563	0.9063	0.14	0.13															
	72,9	36,068	26,988	3,5	3,3	21	61	55	87	90	94	6	7,5	3,5	3,3	0,28	2,1	1,1	
	1.42	1.0625	0.14	0.13															
42,875 1.688	62,2	25,4	19,05	3,5	0,8	16	53	56	71	76	76	5	4,5	3,5	0,8	0,33	1,8	1	
		1	0.75	0.13	0.03														
	62,2	25,4	22,225	3,5	2,3	20	53	56	70	73	76	3	4,5	3,5	2,3	0,33	1,8	1	
	1	0.875	0.14	0.09															



8.2 Inch single row tapered roller bearings

d 44,45 – 45,618 mm

1.75 – 1.796 in.

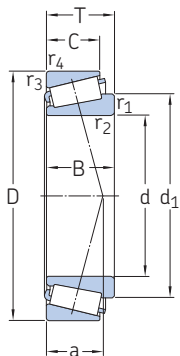

Principal dimensions			Basic load ratings		Fatigue load limit	Speed ratings		Mass	Designation	Series
d	D	T	dynamic	static		Reference speed	Limiting speed			
mm/in.			kN		kN	r/min		kg	–	–
44,45 1.75	82,931	23,812	99,1	106	11,8	6 700	8 000	0,57	25580/25520	25500
	3.265	0.9375								
	82,931	26,988	99,1	106	11,8	6 700	8 000	0,61	25580/25522	25500
	3.265	1.0625								
	82,931	26,988	99,1	106	11,8	6 700	8 000	0,61	25580/25523	25500
	3.265	1.0625								
	88,9	30,162	116	127	14,6	6 000	7 500	0,86	HM 803149/110	HM 803000
	3.5	1.1875								
	93,264	30,163	134	146	17	5 600	7 000	0,98	3782/3720	3700
	3.6718	1.1875								
	95,25	30,958	108	96,5	11,4	5 300	7 000	0,93	▶ 53178/53377	53000
	3.75	1.2188								
45 1.7717	95,25	30,958	124	122	14	5 300	7 000	1	HM 903249/210	HM 903200
	3.75	1.2188								
	104,775	36,512	180	204	22,4	5 000	6 300	1,65	HM 807040/010	HM-807000
	4.125	1.4375								
	107,95	36,512	183	190	21,6	5 300	6 300	1,7	▶ 535/532 X	535
	4.25	1.4375								
45,237 1.781	111,125	38,1	183	190	21,6	5 300	6 300	1,85	▶ 535/532 A	535
	4.375	1.5								
	85	20,638	87,3	81,5	9,3	6 700	8 000	0,5	358 X/354 X	355
	3.3465	0.8125								
	87,312	30,162	126	132	15	6 300	8 000	0,78	3586/3525	3500
	3.4375	1.1875								
	73,431	19,558	66	75	8,15	7 000	8 500	0,31	▶ LM 102949/910	LM 102900
	2.891	0.77								
	77,788	19,842	66,8	69,5	7,65	7 000	8 500	0,37	LM 603049/011	LM 603000
	3.0625	0.7812								
	77,788	19,842	66,8	69,5	7,65	7 000	8 500	0,37	LM 603049/011 AA	LM 603000
	3.0625	0.7812								
77,788	21,43	66,8	69,5	7,65	7 000	8 500	0,39	LM 603049/012	LM 603000	
3.0625	0.8437									
45,618 1.796	82,931	23,812	99,1	106	11,8	6 700	8 000	0,55	25590/25520	25500
	3.265	0.9375								
	82,931	26,988	99,1	106	11,8	6 700	8 000	0,59	25590/25523	25500
	3.265	1.0625								
	83,058	23,876	99,1	106	11,8	6 700	8 000	0,55	25590/25522	25500
	3.27	0.94								

SKF Explorer bearing

▶ Popular item

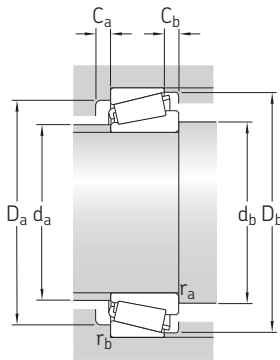

Dimensions			Abutment and fillet dimensions											Calculation factors						
d	d ₁ ≈	B	C	r _{1,2} min.	r _{3,4} min.	a	d _a max.	d _b min.	D _a min.	D _a max.	D _b min.	C _a min.	C _b min.	r _a max.	r _b max.	e	Y	Y ₀		
mm/in.							mm											-		
44,45 1.75	62,2	25,4	19,05	3,5	0,8	16	53	57	71	76	76	5	4,5	3,5	0,8	0,33	1,8	1		
	1	0,75	0,14	0,03																
	62,2	25,4	22,225	3,5	2,3	20	53	57	70	73	76	3	4,5	3,5	2,3	0,33	1,8	1		
	1	0,875	0,14	0,09																
	62,2	25,4	22,225	3,5	2,3	20	53	57	70	73	76	3	4,5	3,5	2,3	0,33	1,8	1		
	1	0,875	0,14	0,09																
	69	29,37	23,02	3,5	3,3	25	53	58	70	77	84	4	7	3,5	3,3	0,54	1,1	0,6		
	1.1563	0,9063	0,14	0,13																
	71,2	30,302	23,812	3,5	3,3	21	60	58	80	81	87	4	6	3,5	3,3	0,33	1,8	1		
	1.193	0,9375	0,14	0,13																
	69,3	28,3	20,638	2	2,3	30	53	55	72	86	89	4	10	2	2,3	0,75	0,8	0,45		
	1.1142	0,8125	0,08	0,09																
	71,6	28,575	22,225	3,5	0,8	30	53	58	71	89	90	4	8,5	3,5	0,8	0,75	0,8	0,45		
	1.125	0,875	0,14	0,03																
	81,5	36,512	28,575	3,5	3,3	28	63	58	85	93	100	6	7,5	3,5	3,3	0,48	1,25	0,7		
	1.4375	1,125	0,14	0,13																
	76,5	36,957	28,575	3,5	3,3	23	64	58	90	96	97	5	7,5	3,5	3,3	0,3	2	1,1		
	1.455	1,125	0,14	0,13																
	76,5	36,957	30,162	3,5	3,3	25	64	58	89	99	97	4	7,5	3,5	3,3	0,3	2	1,1		
	1.455	1,1875	0,14	0,13																
45 1.7717	62,4	21,692	17,462	2	1,5	15	55	55	76	77	80	3	3	2	1,5	0,31	1,9	1,1		
	0,854	0,6875	0,08	0,06																
45,237 1.781	63,1	30,886	23,812	3,5	3,3	19	53	58	73	76	80	4	6	3,5	3,3	0,31	1,9	1,1		
	1,216	0,9375	0,14	0,13																
45,242 1.7812	59,4	19,812	15,748	3,5	0,8	14	52	58	66	67	70	3	3,5	3,5	0,8	0,3	2	1,1		
	0,78	0,62	0,14	0,03																
	62	19,842	15,08	3,5	0,8	17	52	58	68	71	74	4	4,5	3,5	0,8	0,43	1,4	0,8		
	0,7812	0,5937	0,14	0,03																
	62	19,842	15,08	3,5	0,3	17	52	58	68	72	74	4	4,5	3,5	0,3	0,43	1,4	0,8		
	0,7812	0,5937	0,14	0,01																
	62	19,842	16,667	3,5	0,8	18	52	58	67	71	74	3	4,5	3,5	0,8	0,43	1,4	0,8		
	0,7812	0,6562	0,14	0,03																
45,618 1.796	62,1	25,4	19,05	3,5	0,8	16	53	58	71	76	76	5	4,5	3,5	0,8	0,33	1,8	1		
	1	0,75	0,14	0,03																
	62,1	25,4	22,225	3,5	2,3	20	53	58	70	73	76	3	4,5	3,5	2,3	0,33	1,8	1		
	1	0,875	0,14	0,09																
	62,1	25,4	19,114	3,5	2	17	53	58	71	74	76	5	4,5	3,5	2	0,33	1,8	1		
	1	0,7525	0,14	0,08																



8.2 Inch single row tapered roller bearings

d 46 – 50,8 mm

1.811 – 2 in.

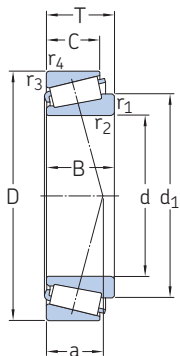

Principal dimensions			Basic load ratings		Fatigue load limit	Speed ratings		Mass	Designation	Series
d	D	T	dynamic	static		Reference speed	Limiting speed			
mm/in.			kN		kN	r/min		kg	–	–
46 1.811	75	18	62,1	71	7,65	7 000	8 500	0,3	▶ LM 503349 A/310	LM 503300
	2.9528	0.7087								
46,038 1.8125	75	18	62,1	71	7,65	7 000	8 500	0,3	▶ LM 503349/310	LM 503300
	2.9528	0.7087								
46,625 1.875	79,375	17,462	61,1	62	6,8	7 000	8 500	0,33	▶ 18690/18620	18600
	3.125	0.6875	87,3	81,5	9,3	6 700	8 000	0,49	359 S/354 X	355
	85	20,638								
3.3465	0.8125									
47,212 1.9375	88,9	20,638	94	91,5	10,4	6 300	7 500	0,55	369 S/362 A	365
	3.5	0.8125	133	146	17,3	5 600	7 000	0,99	HM 804846/810	HM 804800
	95,25	30,162								
	3.75	1.1875	184	190	21,6	5 600	6 700	1,3	528 R/522	525
101,6	34,925									
4	1.375									
50,8 2	114,3	44,45	226	224	25	5 000	6 300	2,2	65390/65320	65300
	4.5	1.75	88,9	100	11	6 300	8 000	0,43	LM 104949/911	LM 104900
	82,55	21,59								
	3.25	0.85	62,1	65,5	7,2	6 300	8 000	0,37	18790/18720	18700
	85	17,462								
	3.3465	0.6875	94	91,5	10,4	6 300	7 500	0,5	368 A/362 A	365
	88,9	20,638								
	3.5	0.8125	94	91,5	10,4	6 300	7 500	0,58	368 A/362 X	365
	90	25								
	3.5433	0.9843	134	146	17	5 600	7 000	0,87	3780/3720	3700
93,264	30,162									
3.6718	1.1875	180	204	22,4	5 000	6 300	1,5	HM 807046/010	HM 807000	
104,775	36,512									
4.125	1.4375	195	224	25	5 300	6 300	1,65	▶ 4580/4535	4500	
104,775	39,688									
4.125	1.5625	183	190	21,6	5 300	6 300	1,55	▶ 537/532 X	535	
107,95	36,512									
4.25	1.4375									

SKF Explorer bearing

▶ Popular item

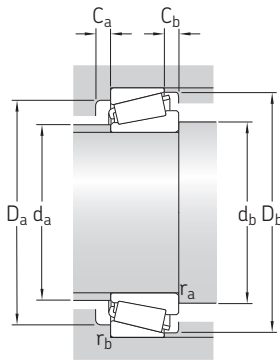

Dimensions				Abutment and fillet dimensions										Calculation factors					
d	d ₁ ≈	B	C	r _{1,2} min.	r _{3,4} min.	a	d _a max.	d _b min.	D _a min.	D _a max.	D _b min.	C _a min.	C _b min.	r _a max.	r _b max.	e	Y	Y ₀	
mm/in.							mm										-		
46 1.811	61	18 0.7087	14 0.5512	3,6 0.14	1,6 0.06	15	53	59	67	67	71	3	4	3,6	1,6	0,4	1,5	0,8	
	61	18 0.7087	14 0.5512	2,3 0.09	1,6 0.06	15	53	56	67	67	71	3	4	2,3	1,6	0,4	1,5	0,8	
46,038 1.8125	60,2	17,462 0.6875	13,495 0.5313	2,8 0.11	1,5 0.06	14	53	57	69	71	73	3	3,5	2,8	1,5	0,37	1,6	0,9	
	62,4	21,692 0.854	17,462 0.6875	2,3 0.09	1,5 0.06	15	55	57	76	77	80	3	3	2,3	1,5	0,31	1,9	1,1	
47,625 1.875	66,2	22,225 0.875	16,513 0.6501	2,3 0.09	1,3 0.05	16	58	58	80	81	83	4	4	2,3	1,3	0,31	1,9	1,1	
	73,6	29,37 1.1563	23,02 0.9063	3,5 0.14	3,3 0.13	25	57	61	76	84	90	5	7	3,5	3,3	0,54	1,1	0,6	
	72,9	36,068 1.42	26,988 1.0625	8 0.32	3,3 0.13	21	61	70	87	90	94	6	7,5	8	3,3	0,28	2,1	1,1	
49,212 1.9375	79,3	44,45 1.75	34,925 1.375	3,5 0.14	3,3 0.13	31	60	63	89	102	105	5	9,5	3,5	3,3	0,43	1,4	0,8	
50,8 2	65,2	22,225 0.875	16,51 0.65	3,5 0.13	1,3 0.05	15	57	64	75	75	78	5	5	3,5	1,3	0,3	2	1,1	
	66	17,462 0.6875	13,495 0.5313	3,5 0.14	1,5 0.06	16	59	64	75	77	79	3	3,5	3,5	1,5	0,4	1,5	0,8	
	66,2	22,225 0.875	16,513 0.6501	3,5 0.14	1,3 0.05	16	58	64	80	81	83	4	4	3,5	1,3	0,31	1,9	1,1	
	66,2	22,225 0.875	20 0.7874	3,5 0.14	2 0.08	20	58	64	78	81	83	3	5	3,5	2	0,31	1,9	1,1	
	71,2	30,302 1.193	23,812 0.9375	3,5 0.14	3,3 0.13	21	60	64	80	81	87	4	6	3,5	3,3	0,33	1,8	1	
	81,5	36,512 1.4375	28,575 1.125	3,5 0.14	3,3 0.13	28	63	64	85	93	100	6	7,5	3,5	3,3	0,48	1,25	0,7	
	79,5	40,157 1.581	33,338 1.3125	3,5 0.14	3,3 0.13	27	65	64	87	93	98	5	6	3,5	3,3	0,33	1,8	1	
	76,5	36,957 1.455	28,575 1.125	3,5 0.14	3,3 0.13	23	64	64	90	96	97	5	7,5	3,5	3,3	0,3	2	1,1	



8.2 Inch single row tapered roller bearings

d 53,975 – 60,325 mm
2.125 – 2.375 in.

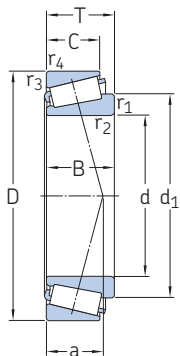

Principal dimensions			Basic load ratings		Fatigue load limit	Speed ratings		Mass	Designation	Series
d	D	T	dynamic	static		Reference speed	Limiting speed			
mm/in.			kN		kN	r/min		kg	–	–
53,975 2.125	88,9	19,05	71,5	78	9	6 000	7 000	0,44	LM 806649/610	LM 806600
	3,5	0,75								
	95,25	27,783	129	137	16	5 600	7 000	0,81	33895/33821	33800
	3,75	1,0938								
	95,25	27,783	129	137	16	5 600	7 000	0,81	33895/33822	33800
	3,75	1,0938								
	107,95	36,512	183	190	21,6	5 300	6 300	1,45	▶ 539/532 X	535
4,25	1,4375									
111,125	38,1	183	190	21,6	5 300	6 300	1,65	▶ 539/532 A	535	
4,375	1,5									
123,825	36,512	174	160	19,6	4 300	5 600	2	72212/72487	72000	
4,875	1,4375									
57,15 2.25	96,838	21	99,9	102	11,6	5 600	6 700	0,59	387 A/382 A	385
	3,8125	0,8268								
	96,838	21	99,9	102	11,6	5 600	6 700	0,59	387/382 A	385
	3,8125	0,8268								
	96,838	25,4	99,9	102	11,6	5 600	6 700	0,65	387 A/382 S	385
	3,8125	1								
	98,425	21	99,9	102	11,6	5 600	6 700	0,64	387/382	385
	3,875	0,8268								
	104,775	30,162	150	160	18,6	5 300	6 300	1,05	▶ 462/453 X	455
	4,125	1,1875								
112,712	30,162	175	204	23,6	4 500	5 600	1,4	39580/39520	39500	
4,4375	1,1875									
112,712	30,162	175	204	23,6	4 500	5 600	1,4	▶ 39581/39520	39500	
4,4375	1,1875									
119,985	32,751	175	204	23,6	4 500	5 600	1,75	39580/39528	39500	
4,7238	1,2894									
119,985	32,751	175	204	23,6	4 500	5 600	1,75	39581/39528	39500	
4,7238	1,2894									
59,987 2.3617	130,175	34,099	187	180	22	3 800	5 000	2,05	HM 911244/210	HM 911200
	5,125	1,3425								
	135,755	53,975	353	400	45,5	4 000	5 000	3,95	6391/K-6320	6300
5,3447	2,125									
60,325 2.375	130,175	36,512	187	180	22,4	3 800	5 000	2,1	HM 911245/210	HM 911200
	5,125	1,4375								

SKF Explorer bearing
▶ Popular item

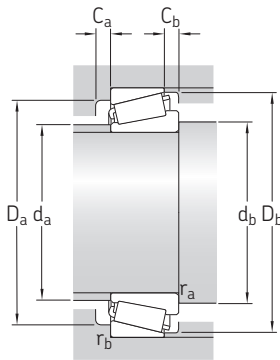

Dimensions				Abutment and fillet dimensions										Calculation factors					
d	d ₁ ≈	B	C	r _{1,2} min.	r _{3,4} min.	a	d _a max.	d _b min.	D _a min.	D _a max.	D _b min.	C _a min.	C _b min.	r _a max.	r _b max.	e	Y	Y ₀	
mm/in.							mm										-		
53,975 2.125	72,1	19,05	13,492	2,3	2	20	62	65	78	80	84	4	5,5	2,3	2	0,54	1,1	0,6	
		0,75	0,5312	0,09	0,08														
	72,5	28,575	22,225	1,5	2,3	20	61	63	83	85	90	6	5,5	1,5	2,3	0,33	1,8	1	
		1,125	0,875	0,06	0,09														
	72,5	28,575	22,225	1,5	0,8	20	61	63	83	88	90	6	5,5	1,5	0,8	0,33	1,8	1	
		1,125	0,875	0,06	0,03														
	76,5	36,957	28,575	3,5	3,3	23	64	67	90	96	97	5	7,5	3,5	3,3	0,3	2	1,1	
		1,455	1,125	0,14	0,13														
	76,5	36,957	30,162	3,5	3,3	25	64	67	89	99	97	4	7,5	3,5	3,3	0,3	2	1,1	
		1,455	1,1875	0,14	0,13														
89,2	32,791	25,4	3,5	3,3	36	67	68	93	112	114	4	11	3,5	3,3	0,75	0,8	0,45		
	1,291	1	0,14	0,13															
57,15 2.25	74,2	21,946	15,875	3,5	0,8	17	65	70	87	90	91	5	5	3,5	0,8	0,35	1,7	0,9	
		0,864	0,625	0,14	0,03														
	74,1	21,946	15,875	2,3	0,8	17	65	68	87	90	91	5	5	2,3	0,8	0,35	1,7	0,9	
		0,864	0,625	0,09	0,03														
	74,2	21,946	20,274	3,5	2,3	21	65	70	85	87	91	3	5	3,5	2,3	0,35	1,7	0,9	
		0,864	0,7982	0,14	0,09														
	74,1	21,946	17,826	2,3	0,8	17	65	68	87	91	92	5	3	2,3	0,8	0,35	1,7	0,9	
		0,864	0,7018	0,09	0,03														
	79	29,317	24,605	2,3	3,3	23	68	68	91	93	98	4	5,5	2,3	3,3	0,33	1,8	1	
		1,52	0,9687	0,09	0,13														
88,3	30,162	23,812	3,5	3,3	23	76	71	100	100	107	6	6	3,5	3,3	0,33	1,8	1		
	1,1875	0,9375	0,14	0,13															
88,3	30,162	23,812	8	3,3	23	76	80	100	100	107	6	6	8	3,3	0,33	1,8	1		
	1,1875	0,9375	0,32	0,13															
88,3	30,162	26,949	3,5	0,8	25	76	71	99	113	107	4	5,5	3,5	0,8	0,33	1,8	1		
	1,1875	1,061	0,14	0,03															
88,3	30,162	26,949	8	0,8	25	76	80	99	113	107	4	5,5	8	0,8	0,33	1,8	1		
	1,1875	1,061	0,32	0,03															
59,987 2.3617	97,1	30,924	23,812	3,5	3,3	40	74	74	102	118	124	5	10	3,5	3,3	0,83	0,72	0,4	
		1,2175	0,9375	0,14	0,13														
97,5	56,007	44,45	3,5	3,3	34	78	74	110	123	125	7	9,5	3,5	3,3	0,33	1,8	1		
	2,205	1,75	0,14	0,13															
60,325 2.375	97,2	33,39	23,812	5	3,3	40	74	77	102	118	124	5	12,5	5	3,3	0,83	0,72	0,4	
		1,3146	0,9375	0,20	0,13														



8.2 Inch single row tapered roller bearings

d 63,5 – 71,438 mm

2.5 – 2.8125 in.

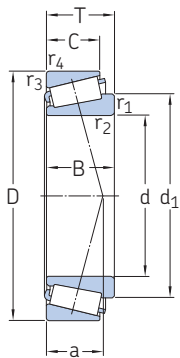

Principal dimensions			Basic load ratings		Fatigue load limit	Speed ratings		Mass	Designation	Series
d	D	T	dynamic	static		Reference speed	Limiting speed			
mm/in.			kN		kN	r/min		kg	–	–
63,5 2.5	110	22	108	118	13,4	4 800	6 000	0,84	395/394 A	395
	4.3307	0.8661								
	112,712	30,162	175	204	23,6	4 500	5 600	1,25	39585/39520	39500
	4.4375	1.1875								
	112,712	30,163	152	183	21,2	4 800	5 600	1,25	3982/3920	3980
	4.4375	1.1875								
65,088 2.5625	135,755	53,975	353	400	45,5	4 000	5 000	3,7	6379/K-6320	6300
	5.3447	2.125								
66,675 2.625	110	22	108	118	13,4	4 800	6 000	0,78	395 S/394 A	395
	4.3307	0.8661								
	110	22	108	118	13,4	4 800	6 000	0,79	395 A/394 A	395
	4.3307	0.8661								
	112,712	30,162	152	183	21,2	4 800	5 600	1,15	3984/3920	3900
	4.4375	1.1875								
	112,712	30,162	175	204	23,6	4 500	5 600	1,2	39590/39520	39500
	4.4375	1.1875								
	119,985	32,751	175	204	23,6	4 500	5 600	1,55	39590/39528	39500
	4.7238	1.2894								
122,238	38,1	229	245	28	4 500	5 300	1,85	▶ HM 212049/011	HM 212000	
4.8125	1.5									
	135,755	53,975	353	400	45,5	4 000	5 000	3,65	6386/K-6320	6300
	5.3447	2.125								
69,85 2.75	112,712	25,4	121	156	17,6	4 500	5 300	0,97	29675/29620	29600
	4.4375	1								
	120	29,795	163	186	21,6	4 500	5 300	1,35	482/472	475
	4.7244	1.173								
	120	32,545	188	228	26,5	4 300	5 300	1,5	▶ 47487/47420	47400
	4.7244	1.2813								
	120	32,545	188	228	26,5	4 300	5 300	1,5	▶ 47487/47420 A	47400
	4.7244	1.2813								
	127	36,512	217	255	29	4 300	5 000	1,95	566/563	565
	5	1.4375								
152,4	41,275	270	320	35,5	3 600	4 300	3,65	655/652	655	
6	1.625									
71,438 2.8125	117,475	30,162	152	190	21,6	4 500	5 300	1,25	33281/33462	33000
	4.625	1.1875								
	136,525	46,038	273	355	39	3 800	4 500	3,1	H 715345/311	H 715300
	5.375	1.8125								

SKF Explorer bearing

▶ Popular item

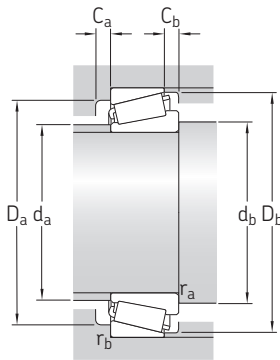

Dimensions			Abutment and fillet dimensions										Calculation factors					
d	d ₁ ≈	B	C	r _{1,2} min.	r _{3,4} min.	a	d _a max.	d _b min.	D _a min.	D _a max.	D _b min.	C _a min.	C _b min.	r _a max.	r _b max.	e	Y	Y ₀
mm/in.						mm										-		
63,5 2.5	86,5	21,996 0.866	18,824 0.7411	3,5 0.14	1,3 0.05	20	77	77	98	102	105	4	3	3,5	1,3	0,4	1,5	0,8
	88,4	30,162 1.1875	23,812 0.9375	3,5 0.14	3,3 0.13	23	76	77	100	100	107	6	6	3,5	3,3	0,33	1,8	1
	87,9	30,048 1.183	23,812 0.9375	3,5 0.14	3,3 0.13	25	75	77	96	101	105	4	6	3,5	3,3	0,4	1,5	0,8
65,088 2.5625	97,5	56,007 2.205	44,45 1.75	3,5 0.14	3,3 0.13	34	78	79	110	123	125	7	9,5	3,5	3,3	0,33	1,8	1
66,675 2.625	86,5	21,996 0.866	18,824 0.7411	3,5 0.14	1,3 0.05	20	77	80	98	102	105	4	3	3,5	1,3	0,4	1,5	0,8
	86,5	21,996 0.866	18,824 0.7411	0,8 0.03	1,3 0.05	20	77	75	98	102	105	4	3	0,8	1,3	0,4	1,5	0,8
	87,9	30,048 1.183	23,812 0.9375	3,5 0.14	3,3 0.13	25	75	80	96	101	105	4	6	3,5	3,3	0,4	1,5	0,8
	88,3	30,162 1.1875	23,812 0.9375	3,5 0.14	3,3 0.13	23	76	80	100	100	107	6	6	3,5	3,3	0,33	1,8	1
	88,3	30,162 1.1875	26,949 1.061	3,5 0.14	0,8 0.32	25	76	80	99	113	107	4	5,5	3,5	0,8	0,33	1,8	1
	90,9	38,354 1.5	29,718 1.17	3,5 0.14	3,3 0.13	26	76	80	106	110	115	7	8	3,5	3,3	0,33	1,8	1
	97,5	56,007 2.205	44,45 1.75	4,3 0.17	3,3 0.13	34	78	82	110	123	125	7	9,5	4,3	3,3	0,33	1,8	1
69,85 2.75	94,4	25,4 1	19,05 0.75	1,5 0.06	3,3 0.13	26	82	80	100	100	108	4	6	1,5	3,3	0,48	1,25	0,7
	92,5	29,007 1.142	24,237 0.9542	3,5 0.14	2 0.08	25	80	84	103	110	112	4	5,5	3,5	2	0,37	1,6	0,9
	94,3	32,545 1.2813	26,195 1.0313	3,5 0.14	3,3 0.13	25	81	84	105	108	113	6	6	3,5	3,3	0,35	1,7	0,9
	94,3	32,545 1.2813	26,195 1.0313	3,5 0.14	0,5 0.02	25	81	84	105	113	113	6	6	3,5	0,5	0,35	1,7	0,9
	97,6	36,17 1.424	28,575 1.125	3,5 0.14	3,3 0.13	28	83	84	109	115	119	5	7,5	3,5	3,3	0,37	1,6	0,9
	113	41,275 1.625	31,75 1.25	3,5 0.14	3,3 0.13	32	96	84	125	140	138	6	9,5	3,5	3,3	0,4	1,5	0,8
71,438 2.8125	94,1	30,162 1.1875	23,812 0.9375	3,5 0.14	3,3 0.13	26	81	85	101	105	111	5	6	3,5	3,3	0,44	1,35	0,8
	110	46,038 1.8125	36,513 1.4375	3,5 0.14	3,3 0.13	36	88	86	113	124	132	7	9,5	3,5	3,3	0,48	1,25	0,7



8.2 Inch single row tapered roller bearings

d 73,025 – 88,9 mm

2.875 – 3.5 in.

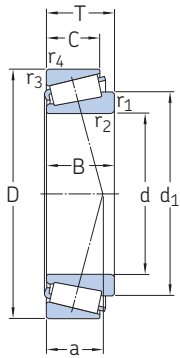

Principal dimensions			Basic load ratings		Fatigue load limit	Speed ratings		Mass	Designation	Series
d	D	T	dynamic	static		Reference speed	Limiting speed			
mm/in.			kN		kN	r/min		kg	–	–
73,025 2.875	112,712	25,4	121	156	17,6	4 500	5 300	0,89	29685/29620	29600
	4.4375	1								
	117,475	30,162	152	190	21,6	4 500	5 300	1,2	33287/33462	33000
	4.625	1.1875								
	127	36,512	217	255	29	4 300	5 000	1,85	567/563	565
	5	1.4375								
76 2.9921	132	39	255	305	34,5	4 000	4 800	2,15	HM 215249/210	HM 215200
	5.1969	1.5354								
76,2 3	109,538	19,05	72,1	102	11	4 500	5 600	0,57	▶ L 814749/710	L 814700
	4.3125	0.75								
	127	30,162	171	204	24	4 000	5 000	1,45	▶ 42687/42620	42600
	5	1.1875								
	133,35	33,338	202	260	30	3 800	4 800	1,95	47678/47620	47600
	5.25	1.3125								
	139,992	36,512	227	280	31	3 800	4 500	2,45	575/572	575
	5.5115	1.4375								
	161,925	49,212	318	335	38	3 000	4 000	4,4	9285/9220	9200
	6.375	1.9375								
77,788 3.0625	121,442	24,608	115	134	15,3	4 300	5 300	0,92	34306/34478	34000
	4.7812	0.9688								
	127	30,163	171	204	24	4 000	5 000	1,4	▶ 42690/42620	42600
	5	1.1875								
82,55 3.25	139,992	36,512	227	280	31	3 800	4 500	2,2	580/572	575
	5.5115	1.4375								
	146,05	41,275	270	320	35,5	3 600	4 300	2,8	663/653	655
	5.75	1.625								
	150,089	44,45	351	405	46,5	3 600	4 300	3,4	749 A/742	745
	5.909	1.75								
85,725 3.375	133,35	30,163	178	220	25,5	3 800	4 500	1,45	497/492 A	495
	5.25	1.1875								
	146,05	41,275	270	320	35,5	3 600	4 300	2,65	665/653	655
	5.75	1.625								
88,9 3.5	152,4	39,688	237	305	33,5	3 400	4 300	2,8	593/592 A	593
	6	1.5625								
	152,4	39,688	300	355	39	3 400	4 000	2,85	HM 518445/410	HM 518400
	6	1.5625								
	161,925	53,975	404	510	56	3 200	4 000	4,8	6580/6535	6500
	6.375	2.125								

SKF Explorer bearing

▶ Popular item

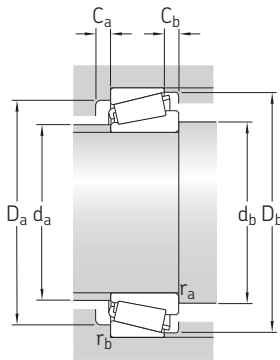

Dimensions			Abutment and fillet dimensions										Calculation factors						
d	d ₁ ≈	B	C	r _{1,2} min.	r _{3,4} min.	a	d _a max.	d _b min.	D _a min.	D _a max.	D _b min.	C _a min.	C _b min.	r _a max.	r _b max.	e	Y	Y ₀	
mm/in.							mm										-		
73,025 2.875	94,4	25,4	19,05	3,5	3,3	26	82	87	100	100	108	4	6	3,5	3,3	0,48	1,25	0,7	
	1	0,75	0,14	0,13															
	94,1	30,162	23,812	3,5	3,3	26	81	87	101	105	111	5	6	3,5	3,3	0,44	1,35	0,8	
	1,1875	0,9375	0,14	0,13															
	97,6	36,17	28,575	3,5	3,3	28	83	87	109	115	119	5	7,5	3,5	3,3	0,37	1,6	0,9	
	1,424	1,125	0,14	0,13															
76 2.9921	102	39	32	7	3,5	27	88	97	116	119	126	7	7	7	3,5	0,33	1,8	1	
	1,5354	1,2598	0,28	0,14															
76,2 3	94,5	19,05	15,083	1,5	1,5	23	85	86	98	101	105	3	3,5	1,5	1,5	0,5	1,2	0,7	
	0,75	0,5938	0,06	0,06															
	101	31	22,225	3,5	3,3	26	88	90	112	114	120	5	7,5	3,5	3,3	0,43	1,4	0,8	
	1,2205	0,875	0,14	0,13															
	107	33,338	26,195	6,4	3,3	29	93	96	117	121	126	5	7	6,4	3,3	0,4	1,5	0,8	
1,3125	1,0313	0,25	0,13																
	109	36,098	28,575	3,5	3,3	30	94	90	120	127	131	5	7,5	3,5	3,3	0,4	1,5	0,8	
	1,4212	1,125	0,14	0,13															
	121	46,038	31,75	3,5	3,3	47	93	91	128	149	153	7	17	3,5	3,3	0,72	0,84	0,45	
	1,8125	1,25	0,14	0,13															
77,788 3.0625	97,8	23,012	17,462	3,5	2	25	88	92	108	112	114	3	7	3,5	2	0,46	1,3	0,7	
	0,906	0,6875	0,14	0,08															
	101	31	22,225	3,5	3,3	26	88	92	112	114	120	5	7,5	3,5	3,3	0,43	1,4	0,8	
	1,2205	0,875	0,14	0,13															
82,55 3.25	109	36,098	28,575	3,5	3,3	30	94	97	120	127	131	5	7,5	3,5	3,3	0,4	1,5	0,8	
	1,4212	1,125	0,14	0,13															
	113	41,275	31,75	3,5	3,3	32	96	97	125	133	138	6	9,5	3,5	3,3	0,4	1,5	0,8	
	1,625	1,25	0,14	0,13															
	113	46,672	36,512	3,5	3,3	31	95	97	130	137	142	8	7,5	3,5	3,3	0,33	1,8	1	
	1,8375	1,4375	0,14	0,13															
85,725 3.375	108	29,769	22,225	3,5	3,3	29	95	100	119	121	128	5	7,5	3,5	3,3	0,44	1,35	0,8	
	1,172	0,875	0,14	0,13															
	113	41,275	31,75	3,5	3,3	32	96	100	125	133	138	6	9,5	3,5	3,3	0,4	1,5	0,8	
	1,625	1,25	0,14	0,13															
88,9 3.5	121	36,322	30,162	3,5	3,3	36	104	103	128	139	141	4	9,5	3,5	3,3	0,44	1,35	0,8	
	1,43	1,1875	0,14	0,13															
	119	39,688	30,162	6,4	3,3	32	102	109	135	139	146	7	9,5	6,4	3,3	0,4	1,5	0,8	
	1,5625	1,1875	0,25	0,13															
	125	55,1	42,862	3,5	3,3	39	102	103	134	149	153	8	11	3,5	3,3	0,4	1,5	0,8	
	2,1693	1,6875	0,14	0,13															



8.2 Inch single row tapered roller bearings

d 90 – 110 mm
3.5433 – 4.3307 in.

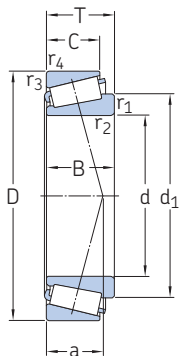

Principal dimensions			Basic load ratings		Fatigue load limit	Speed ratings		Mass	Designation	Series
d	D	T	dynamic	static		Reference speed	Limiting speed			
mm/in.			kN		kN	r/min		kg	–	–
90 3.5433	147	40	280	355	39	3 400	4 300	2,55	HM 218248/210	HM 218200
	5.7874 161,925 6.375	1.5748 53,975 2.125	404	510	56	3 200	4 000	4,75	6581 X/6535	6500
92,075 3.625	146,05	33,338	209	280	31,5	3 400	4 300	2,1	47890/47820	47800
	5.75 152,4 6	1.3125 39,688 1.5625	237	305	33,5	3 400	4 300	2,7	598/592 A	595
95,25 3.75	146,05	33,338	209	280	31,5	3 400	4 300	1,95	47896/47820	47800
	5.75	1.3125	237	305	33,5	3 400	4 300	2,55	594 A/592 A	595
	152,4 6	39,688 1.5625	237	305	33,5	3 400	4 300	2,55	594/592 A	595
	152,4 6	39,688 1.5625	237	305	33,5	3 400	4 300	2,55	594/592 A	595
	168,275 6.625	41,275 1.625	288	365	39	3 000	3 800	3,75	683/672	675
96,838 3.8125	188,912 7.4375	50,8 2	348	375	41,5	2 600	3 400	5,75	90381/90744	90300
99,975 3.936	212,725 8.375	66,675 2.625	619	830	88	2 200	3 000	11,5	HH 224334/310	HH 224300
100 3.937	157	42	303	400	42,5	3 200	4 000	2,9	HM 220149 A/110	HM 220100
	6.1811 157 6.1811	1.6535 42 1.6535	303	400	42,5	3 200	4 000	2,9	HM 220149/110	HM 220100
101,6 4	168,275 6.625	41,275 1.625	288	365	39	3 000	3 800	3,45	687/672	675
	190,5 7.5	57,15 2.25	537	630	68	2 800	3 400	7	HH 221449/410	HH 221400
	212,725 8.375	66,675 2.625	619	830	88	2 200	3 000	11	HH 224335/310	HH 224300
107,95 4.25	158,75 6.25	23,02 0.9063	124	163	18,3	3 200	3 800	1,4	37425/37625	37000
	165,1 6.5	36,512 1.4375	256	355	37,5	3 000	3 600	2,7	56425/56650	56000
110 4.3307	180 7.0866	41,275 1.625	307	415	42,5	2 800	3 400	3,95	64432/64708	64000

SKF Explorer bearing
► Popular item

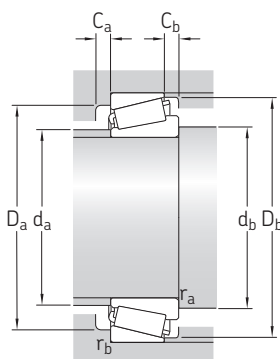

Dimensions				Abutment and fillet dimensions										Calculation factors					
d	d ₁ ≈	B	C	r _{1,2} min.	r _{3,4} min.	a	d _a max.	d _b min.	D _a min.	D _a max.	D _b min.	C _a min.	C _b min.	r _a max.	r _b max.	e	Y	Y ₀	
mm/in.							mm										-		
90 3.5433	116	40	32,5	7	3,5	29	101	111	130	134	140	7	7,5	7	3,5	0,33	1,8	1	
	125	55,1 2.1693	42,862 1.6875	3 0.12	3,3 0.13	39	102	104	134	149	153	8	11	3	3,3	0,4	1,5	0,8	
92,075 3.625	120	34,925	26,195	3,5	3,3	32	105	106	128	133	139	6	7	3,5	3,3	0,44	1,35	0,8	
	121	36,322 1.43	30,162 1.1875	3,5 0.14	3,3 0.13	36	104	107	128	139	141	4	9,5	3,5	3,3	0,44	1,35	0,8	
95,25 3.75	120	34,925	26,195	3,5	3,3	32	105	110	128	133	139	6	7	3,5	3,3	0,44	1,35	0,8	
	121	36,322 1.43	30,162 1.1875	5 0.20	3,3 0.13	36	104	113	128	139	141	4	9,5	5	3,3	0,44	1,35	0,8	
	121	36,322 1.43	30,162 1.1875	3,5 0.14	3,3 0.13	36	104	110	128	139	141	4	9,5	3,5	3,3	0,44	1,35	0,8	
96,838 3.8125	145	46,038 1.8125	31,75 1.25	3,5 0.14	3,3 0.13	61	114	112	148	176	179	6	19	3,5	3,3	0,88	0,68	0,4	
	158	66,675 2.625	53,975 2.125	3,5 0.14	3,3 0.13	46	132	115	184	199	202	10	12,5	3,5	3,3	0,33	1,8	1	
100 3.937	127	42	34	5	3,5	31	111	118	140	143	151	7	8	5	3,5	0,33	1,8	1	
	127	42	34	8	3,5	31	111	124	140	143	151	7	8	8	3,5	0,33	1,8	1	
101,6 4	133	41,275	30,162	3,5	3,3	38	114	116	143	155	157	6	11	3,5	3,3	0,48	1,25	0,7	
	142	57,531 2.265	46,038 1.8125	8 0.32	3,3 0.13	40	119	126	163	177	179	9	11	8	3,3	0,33	1,8	1	
	158	66,675 2.625	53,975 2.125	7 0.28	3,3 0.13	46	132	124	184	199	202	10	12,5	7	3,3	0,33	1,8	1	
107,95 4.25	132	21,438 0.844	15,875 0.625	3,5 0.14	3,3 0.13	36	120	123	140	145	149	4	7	3,5	3,3	0,6	1	0,6	
	137	36,512 1.4375	26,988 1.0625	3,5 0.14	3,3 0.13	37	119	123	145	152	158	6	9,5	3,5	3,3	0,5	1,2	0,7	
110 4.3307	146	41,275 1.625	30,162 1.1875	3,5 0.14	3,3 0.13	41	126	125	155	167	171	6	11	3,5	3,3	0,52	1,15	0,6	



8.2 Inch single row tapered roller bearings

d 114,3 – 152,4 mm

4.5 – 6 in.

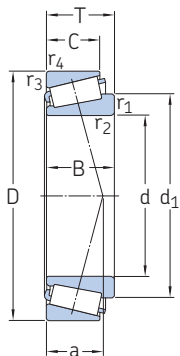

Principal dimensions			Basic load ratings		Fatigue load limit	Speed ratings		Mass	Designation	Series
d	D	T	dynamic	static		Reference speed	Limiting speed			
mm/in.			kN		kN	r/min		kg	–	–
114,3 4.5	177,8	41,275	307	415	42,5	2 800	3 400	3,6	64450/64700	64000
	7	1.625								
	180,975	34,925	227	280	30	2 800	3 400	2,95	68450/68712	68000
	7.125	1.375								
	212,725	66,675	619	830	88	2 200	3 000	10	HH 224346/310	HH 224300
	8.375	2.625								
	212,725	66,675	626	765	81,5	2 600	3 200	10	938/932	935
	8.375	2.625								
114,975 4.5266	212,725	66,675	619	830	88	2 200	3 000	10	HH 224349/310	HH 224300
	8.375	2.625								
120,65 4.75	190,5	46,038	388	540	56	2 600	3 200	4,85	HM 624749/710	HM 624700
	7.5	1.8125								
127 5	182,562	39,688	281	440	44	2 600	3 200	3,3	48290/48220	48200
	7.1875	1.5625								
	196,85	46,038	395	585	60	2 400	3 000	5,2	67388/67322	67300
	7.75	1.8125								
	206,375	47,625	424	585	61	2 400	3 000	6,1	798/792	795
	8.125	1.875								
133,35 5.25	177,008	25,4	166	280	28	2 600	3 200	1,7	▶ L 327249/210	L 327200
	6.9688	1								
	196,85	46,038	395	585	60	2 400	3 000	4,65	67391/67322	67300
	7.75	1.8125								
	234,95	63,5	683	900	91,5	2 200	2 800	11	95525/95925	95000
	9.25	2.5								
139,7 5.5	228,6	57,15	578	800	80	2 200	2 800	8,95	898/892	895
	9	2.25								
	236,538	57,15	629	850	86,5	2 200	2 600	10	HM 231132/110	HM 231100
	9.3125	2.25								
149,225 5.875	236,538	57,15	629	850	86,5	2 200	2 600	9,05	HM 231148/110	HM 231100
	9.3125	2.25								
152,4 6	203,2	41,275	251	480	45,5	2 400	2 800	3,7	LM 330448/410	LM 330400
	8	1.625								
	222,25	46,83	400	630	62	2 200	2 600	5,85	M 231649/610	M 231600
	8.75	1.8437								

SKF Explorer bearing

▶ Popular item

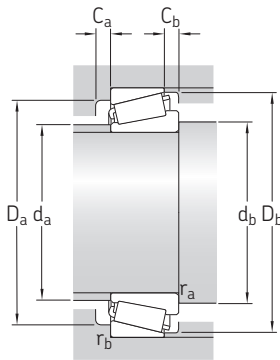

Dimensions			Abutment and fillet dimensions										Calculation factors					
d	d ₁ ≈	B	C	r _{1,2} min.	r _{3,4} min.	a	d _a max.	d _b min.	D _a min.	D _a max.	D _b min.	C _a min.	C _b min.	r _a max.	r _b max.	e	Y	Y ₀
mm/in.						mm										-		
114,3 4.5	146	41,275	30,162	3,5	3,3	41	126	129	155	164	171	6	11	3,5	3,3	0,52	1,15	0,6
		1.625	1.1875	0.14	0.13													
	144	31,75	25,4	3,5	3,3	39	129	129	158	167	170	4	9,5	3,5	3,3	0,5	1,2	0,7
		1.25	1	0.14	0.13													
	158	66,675	53,975	7	3,3	46	131	137	184	199	202	10	12,5	7	3,3	0,33	1,8	1
		2.625	2.125	0.28	0.13													
	154	66,675	53,975	7	3,3	46	130	137	175	199	193	8	12,5	7	3,3	0,33	1,8	1
		2.625	2.125	0.28	0.13													
114,975 4.5266	158	66,675	53,975	7	3,3	46	132	137	184	199	202	10	12,5	7	3,3	0,33	1,8	1
		2.625	2.125	0.28	0.13													
120,65 4.75	156	46,038	34,925	3,5	1,5	41	135	136	167	180	182	8	11	3,5	1,5	0,43	1,4	0,8
		1.8125	1.375	0.14	0.06													
127 5	154	38,1	33,338	3,5	3,3	34	140	142	165	169	174	6	6	3,5	3,3	0,3	2	1,1
		1.5	1.3125	0.14	0.13													
	164	46,038	38,1	3,5	3,3	39	146	142	177	183	189	7	7,5	3,5	3,3	0,35	1,7	0,9
		1.8125	1.5	0.14	0.13													
	167	50,013	34,925	3,3	3,3	45	144	142	178	192	195	8	12,5	3,3	3,3	0,46	1,3	0,7
		1.969	1.375	0.13	0.13													
133,35 5.25	155	26,195	20,638	1,5	1,5	28	145	144	165	167	170	5	4,5	1,5	1,5	0,35	1,7	0,9
		1.0313	0.8125	0.06	0.06													
	164	46,038	38,1	8	3,3	39	146	158	177	183	189	7	7,5	8	3,3	0,35	1,7	0,9
		1.8125	1.5	0.32	0.13													
	178	63,5	49,213	9,7	3,3	48	152	161	198	221	217	10	14	9,7	3,3	0,37	1,6	0,9
		2.5	1.9375	0.38	0.13													
139,7 5.5	181	57,15	44,45	3,5	3,3	49	155	155	195	214	215	8	12,5	3,5	3,3	0,43	1,4	0,8
		2.25	1.75	0.14	0.13													
	187	56,642	44,45	3,5	3,3	44	165	156	210	222	223	9	12,5	3,5	3,3	0,31	1,9	1,1
		2.23	1.75	0.14	0.13													
149,225 5.875	187	56,642	44,45	6,4	3,3	44	165	171	210	222	223	10	12,5	6,4	3,3	0,31	1,9	1,1
		2.23	1.75	0.25	0.13													
152,4 6	180	41,275	34,925	3,3	3,3	38	166	168	186	189	197	5	6	3,3	3,3	0,35	1,7	0,9
		1.625	1.375	0.13	0.13													
	185	46,83	34,925	3,5	1,5	40	169	168	200	211	210	7	11,5	3,5	1,5	0,33	1,8	1
		1.8437	1.375	0.14	0.06													



8.2 Inch single row tapered roller bearings

d 158,75 – 203,2 mm

6.25 – 8 in.

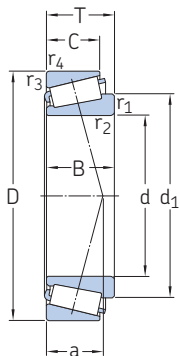

Principal dimensions			Basic load ratings		Fatigue load limit	Speed ratings		Mass	Designation	Series
d	D	T	dynamic	static		Reference speed	Limiting speed			
mm/in.			kN		kN	r/min		kg	–	–
158,75 6.25	205,583	23,812	168	280	27	2 200	2 800	1,9	▶ L 432348/310	L 432300
	8.0938	0.9375								
	205,583	23,813	168	280	27	2 200	2 800	1,95	▶ L 432349/310	L 432300
	8.0938	0.9375								
165,1 6.5	336,55	92,075	1 198	1 700	156	1 400	1 900	37	HH 437549/510	HH 437500
	13.25	3.625								
177,8 7	227,012	30,162	231	425	40	2 000	2 400	2,95	▶ 36990/36920	36900
	8.9375	1.1875								
	288,925	63,5								
	11.375	2.5								
178,595 7.0313	265,112	51,595	532	880	85	1 800	2 200	9,55	M 336948/912	M 336900
	10.4375	2.0313								
179,934 7.084	265,112	51,595	532	880	85	1 800	2 200	9,4	M 336949/912	M 336900
	10.4375	2.0313								
187,325 7.375	282,575	50,8	427	695	67	1 700	2 000	9,9	87737/87111	87000
	11.125	2								
189,738 7.47	279,4	52,388	643	980	93	1 700	2 000	11	M 239447/410	M 239400
	11	2.0625								
190,5 7.5	282,575	50,8	427	695	67	1 700	2 000	9,55	87750/87111	87000
	11.125	2								
196,85 7.75	241,3	23,812	189	315	29	1 900	2 400	2,1	▶ LL 639249/210	LL 639200
	9.5	0.9375								
	257,175	39,688	339	655	58,5	1 800	2 200	5,35	LM 739749/710	LM 739700
	10.125	1.5625								
198,298 7.807	279,4	46,038	465	830	76,5	1 600	2 000	9,2	67981/67919	67900
	11	1.8125								
199,949 7.872	279,4	46,038	465	830	76,5	1 600	2 000	9	67982/67919	67900
	11	1.8125								
200,025 7.875	276,225	42,862	478	780	72	1 700	2 000	7,7	LM 241147/110	LM 241100
	10.875	1.6875								
203,2 8	282,575	46,038	465	830	76,5	1 600	2 000	8,85	67983/67920	67900
	11.125	1.8125								

SKF Explorer bearing

▶ Popular item

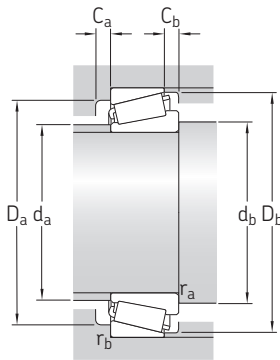

Dimensions			Abutment and fillet dimensions											Calculation factors					
d	d ₁ ≈	B	C	r _{1,2} min.	r _{3,4} min.	a	d _a max.	d _b min.	D _a min.	D _a max.	D _b min.	C _a min.	C _b min.	r _a max.	r _b max.	e	Y	Y ₀	
mm/in.							mm											-	
158,75 6.25	181	23,812 0.9375	18,258 0.7188	4,8 0.19	1,5 0.06	32	172	177	194	195	197	5	5,5	4,8	1,5	0,37	1,6	0,9	
	181	23,812 0.9375	18,258 0.7188	1,5 0.06	1,5 0.06	32	172	170	194	195	197	5	5,5	1,5	1,5	0,37	1,6	0,9	
165,1 6.5	242	95,25 3.75	69,85 2.75	3,3 0.13	6,4 0.25	69	203	182	280	315	308	14	22	3,3	6,4	0,37	1,6	0,9	
177,8 7	203	30,162 1.1875	23,02 0.9063	1,5 0.13	1,5 0.13	42	190	190	212	216	220	5	7	1,5	1,5	0,44	1,35	0,8	
	232	63,5 2.5	47,625 1.875	7 0.28	3,3 0.13	62	201	201	247	274	270	10	15,5	7	3,3	0,46	1,3	0,7	
178,595 7.0313	216	57,15 2.25	38,895 1.5313	3,3 0.13	3,3 0.13	46	196	195	240	250	251	9	12,5	3,3	3,3	0,33	1,8	1	
179,934 7.084	216	57,15 2.25	38,895 1.5313	3,3 0.13	3,3 0.13	46	196	196	240	250	251	9	12,5	3,3	3,3	0,33	1,8	1	
187,325 7.375	232	47,625 1.875	36,512 1.4375	3,5 0.14	3,3 0.13	54	213	204	253	267	267	6	14	3,5	3,3	0,43	1,4	0,8	
189,738 7.47	232	57,15 2.25	41,275 1.625	3,3 0.13	3,3 0.13	48	211	206	254	264	266	9	11	3,3	3,3	0,33	1,8	1	
190,5 7.5	232	47,625 1.875	36,512 1.4375	3,5 0.14	3,3 0.13	54	213	207	253	267	267	6	14	3,5	3,3	0,43	1,4	0,8	
196,85 7.75	217	23,017 0.9062	17,462 0.6875	1,5 0.06	1,5 0.06	40	207	209	232	230	235	5	6	1,5	1,5	0,43	1,4	0,8	
	229	39,688 1.5625	30,162 1.1875	3,5 0.14	3,3 0.13	50	210	213	236	242	247	8	9,5	3,5	3,3	0,44	1,35	0,8	
198,298 7.807	246	49,212 1.9375	36,512 1.4375	3,5 0.14	3,3 0.13	60	223	215	254	264	272	8	9,5	3,5	3,3	0,5	1,2	0,7	
199,949 7.872	246	49,212 1.9375	36,512 1.4375	3,5 0.14	3,3 0.13	60	223	217	254	264	272	8	9,5	3,5	3,3	0,5	1,2	0,7	
200,025 7.875	236	46,038 1.8125	34,133 1.3438	3,5 0.14	3,3 0.13	44	220	217	257	261	265	7	8,5	3,5	3,3	0,31	1,9	1,1	
203,2 8	246	46,038 1.8125	36,512 1.4375	3,5 0.14	3,3 0.13	60	222	220	254	267	272	8	9,5	3,5	3,3	0,5	1,2	0,7	



8.2 Inch single row tapered roller bearings

d 203,987 – 304,8 mm

8.031 – 12 in.

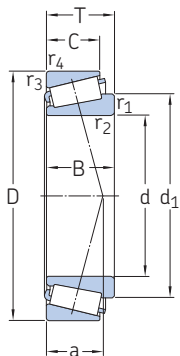

Principal dimensions			Basic load ratings		Fatigue load limit	Speed ratings		Mass	Designation	Series
d	D	T	dynamic	static		Reference speed	Limiting speed			
mm/in.			kN		kN	r/min		kg	–	–
203,987 8.031	276,225 10.875	42,862 1.6875	478	780	72	1 700	2 000	7,2	LM 241148/110	LM 241100
206,375 8.125	282,575 11.125	46,038 1.8125	465	830	76,5	1 600	2 000	8,45	67985/67920	67900
	336,55 13.25	98,425 3.875	1 230	2 160	190	1 300	1 800	34	H 242649/610	H 242600
216,408 8.52	285,75 11.25	46,038 1.8125	466	850	76,5	1 600	2 000	7,9	LM 742747/710	LM 742700
220,662 8.6875	314,325 12.375	61,912 2.4375	784	1 320	118	1 500	1 800	15	M 244249 A/210	M 244200
230,188 9.0625	317,5 12.5	47,625 1.875	556	980	90	1 500	1 800	11	LM 245846/810	LM 245800
231,775 9.125	300,038 11.8125	33,338 1.3125	267	425	39	1 500	1 900	5,2	▶ 544091/544118	544000
	317,5 12.5	47,625 1.875	556	980	90	1 500	1 800	10,5	▶ LM 245848/810	LM 245800
234,848 9.246	314,325 12.375	49,212 1.9375	608	1 000	91,5	1 500	1 800	10,5	▶ LM 545848/810	LM 545800
255,6 10.063	342,9 13.5	57,15 2.25	698	1 400	125	1 300	1 600	15	M 349547/510	M 349500
257,175 10.125	342,9 13.5	57,15 2.25	698	1 400	125	1 300	1 600	14	M 349549/510	M 349500
	358,775 14.125	71,438 2.8125	1 030	1 760	156	1 300	1 600	21,5	M 249747/710	M 249700
263,525 10.375	325,438 12.8125	28,575 1.125	273	550	48	1 400	1 700	5,3	38880/38820	38800
	355,6 14	57,15 2.25	789	1 400	122	1 300	1 600	16	LM 451345/310	LM 451300
292,1 11.5	374,65 14.75	47,625 1.875	539	1 140	98	1 200	1 500	12,5	▶ L 555249/210	L 555200
304,8 12	393,7 15.5	50,8 2	655	1 220	104	1 100	1 400	15	▶ L 357049/010	L 357000
	406,4 16	63,5 2.5	775	1 700	143	1 100	1 300	22,5	LM 757049/010	LM 757000

SKF Explorer bearing

▶ Popular item

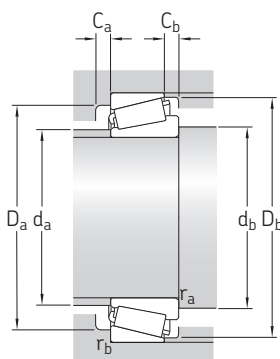

Dimensions			Abutment and fillet dimensions											Calculation factors					
d	d ₁ ≈	B	C	r _{1,2} min.	r _{3,4} min.	a	d _a max.	d _b min.	D _a min.	D _a max.	D _b min.	C _a min.	C _b min.	r _a max.	r _b max.	e	Y	Y ₀	
mm/in.							mm											-	
203,987 8.031	236	46,038 1.8125	34,133 1.3438	3,5 0.14	3,3 0.13	44	220	221	257	261	265	7	8,5	3,5	3,3	0,31	1,9	1,1	
206,375 8.125	246	46,038 1.8125	36,512 1.4375	3,5 0.14	3,3 0.13	60	222	223	254	267	272	8	9,5	3,5	3,3	0,5	1,2	0,7	
	268	100,013 3.9375	77,788 3.0625	3,3 0.13	3,3 0.13	72	231	223	290	321	318	14	20,5	3,3	3,3	0,33	1,8	1	
216,408 8.52	253	49,212 1.9375	34,925 1.375	3,5 0.14	3,3 0.13	60	230	233	261	270	277	7	11	3,5	3,3	0,48	1,25	0,7	
220,662 8.6875	264	66,675 2.625	49,212 1.9375	1,5 0.06	3,3 0.13	56	241	234	284	299	300	9	12,5	1,5	3,3	0,33	1,8	1	
230,188 9.0625	268	52,388 2.0625	36,512 1.4375	3,3 0.13	3,3 0.13	49	249	247	296	302	304	9	11	3,3	3,3	0,31	1,9	1,1	
231,775 9.125	260	31,75 1.25	23,812 0.9375	3,5 0.14	3,3 0.13	49	247	249	278	284	284	5	9,5	3,5	3,3	0,4	1,5	0,8	
	268	52,388 2.0625	36,512 1.4375	3,3 0.13	3,3 0.13	49	249	249	296	302	304	9	11	3,3	3,3	0,31	1,9	1,1	
234,848 9.246	271	53,975 2.125	36,512 1.4375	3,5 0.14	3,3 0.13	57	250	252	291	299	304	9	12,5	3,5	3,3	0,4	1,5	0,8	
255,6 10.063	296	63,5 2.5	44,45 1.75	1,5 0.06	3,3 0.13	59	273	269	318	327	331	9	12,5	1,5	3,3	0,35	1,7	0,9	
257,175 10.125	296	57,15 2.25	44,45 1.75	6,4 0.25	3,3 0.13	59	273	281	318	327	331	9	12,5	6,4	3,3	0,35	1,7	0,9	
	303	76,2 3	53,975 2.125	1,5 0.06	3,3 0.13	64	276	271	326	343	343	11	17	1,5	3,3	0,33	1,8	1	
263,525 10.375	293	28,575 1.125	25,4 1	1,5 0.06	1,5 0.06	48	282	277	307	313	313	4	3	1,5	1,5	0,37	1,6	0,9	
	309	57,15 2.25	44,45 1.75	3,5 0.14	3,3 0.13	61	285	281	329	339	343	10	12,5	3,5	3,3	0,35	1,7	0,9	
292,1 11.5	330	47,625 1.875	34,925 1.375	3,5 0.14	3,3 0.13	64	310	310	350	358	361	9	12,5	3,5	3,3	0,4	1,5	0,8	
304,8 12	347	50,8 2	38,1 1.5	6,4 0.25	3,3 0.13	64	327	329	368	377	379	7	12,5	6,4	3,3	0,35	1,7	0,9	
	356	63,5 2.5	47,625 1.875	6,4 0.25	3,3 0.13	79	327	329	370	389	391	10	15,5	6,4	3,3	0,44	1,35	0,8	



8.2 Inch single row tapered roller bearings

d 317,5 – 457,2 mm

12.5 – 18 in.

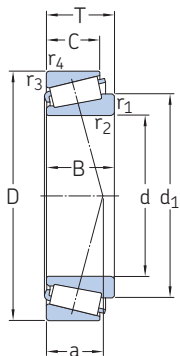

Principal dimensions			Basic load ratings		Fatigue load limit	Speed ratings		Mass	Designation	Series
d	D	T	dynamic	static		Reference speed	Limiting speed			
mm/in.			kN		kN	r/min		kg	–	–
317,5 12.5	447,675 17.625	85,725 3.375	1 363	2 700	220	900	1 200	41	HM 259048/010/HA4	HM 259000
333,375 13.125	469,9 18.5	90,488 3.5625	1 428	2 850	232	850	1 200	47	HM 261049/010	HM 261000
342,9 13.5	450,85 17.75	66,675 2.625	1 000	2 200	180	900	1 200	28	LM 361649/610	LM 361600
343,154 13.51	450,85 17.75	66,675 2.625	1 000	2 200	180	900	1 200	28	LM 361649 A/610	LM 361600
346,075 13.625	488,95 19.25	95,25 3.75	1 533	3 150	255	850	1 100	55	HM 262749/710	HM 262700
381 15	479,425 18.875	49,213 1.9375	638	1 500	120	800	1 100	20	L 865547/512	L 865500
406,4 16	549,275 21.625	85,725 3.375	1 467	3 050	236	700	950	53,5	LM 567949/910/HA1	LM 567900
431,8 17	571,5 22.5	74,612 2.9375	1 145	2 550	204	670	900	49	LM 869448/410	LM 869400
457,2 18	573,088 22.5625	74,612 2.9375	1 205	3 000	228	670	900	43,5	L 570649/610	L 570600

8.2

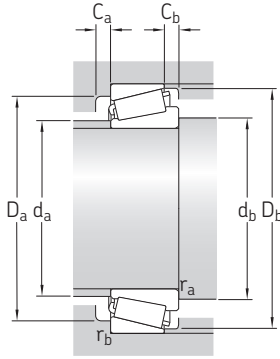

Dimensions				Abutment and fillet dimensions										Calculation factors				
d	d ₁ ≈	B	C	r _{1,2} min.	r _{3,4} min.	a	d _a max.	d _b min.	D _a min.	D _a max.	D _b min.	C _a min.	C _b min.	r _a max.	r _b max.	e	Y	Y ₀
mm/in.							mm										-	
317,5 12.5	376	85,725 3.375	68,262 2.6875	3,5 0.14	3,3 0.13	80	341	339	405	428	428	9	17	3,5	3,3	0,33	1,8	1
333,375 13.125	399	90,488 3.5625	71,438 2.1825	6,4 0.25	3,3 0.13	85	362	365	428	453	452	6	19	6	3,1	0,33	1,8	1
342,9 13.5	393	66,675 2.625	52,388 2.0625	8,5 0.33	3,5 0.14	75	365	385	417	433	434	9	14	7,5	3,3	0,35	1,7	0,9
343,154 13.51	393	66,675 2.625	52,388 2.0625	8,5 0.33	3,5 0.14	75	365	385	417	433	434	9	14	7,5	3,3	0,35	1,7	0,9
346,075 13.625	413	95,25 3.75	74,612 2.9375	6,4 0.25	3,3 0.13	88	379	378	442	472	467	8	21	6	3,1	0,33	1,8	1
381 15	430	47,625 1.875	34,925 1.375	6,4 0.25	3,3 0.13	92	406	413	448	462	463	6	14	6	3,1	0,5	1,2	0,7
406,4 16	473	84,138 3.3125	61,612 2.4257	6,4 0.25	3,3 0.13	100	434	438	502	532	526	9	23,5	6	3,1	0,4	1,5	0,8
431,8 17	500	74,612 2.9375	52,388 2.0625	3,3 0.13	3,3 0.13	120	462	455	520	550	549	8	22	3,3	3,3	0,54	1,1	0,6
457,2 18	516	74,612 2.9375	57,15 2.25	6,4 0.25	6,4 0.25	101	482	489	534	541	556	9	17	6	6	0,4	1,5	0,8



8.3 Single row tapered roller bearings with a flanged outer ring

d 35 – 65 mm

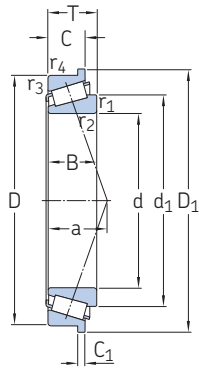

Principal dimensions			Basic load ratings		Fatigue load limit	Speed ratings		Mass	Designation
d	D	T	dynamic	static		Reference speed	Limiting speed		
mm			kN		kN	r/min		kg	–
35	80	22,75	88,9	73,5	8,3	7 500	9 000	0,53	30307 R
		19,75		68					
40	80	19,75	75,8	68	7,65	7 000	8 500	0,44	32008 XR 30208 R
		38,25		166					
45	100	38,25	166	176	20	5 000	6 700	1,55	32309 BR
55	120	45,5	233	260	30	4 300	5 600	2,55	32311 BR
65	140	34	240	208	24	4 800	5 600	1,3	33113 R 30313 R
		36		228					

8.3



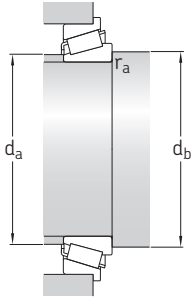

Dimensions									Abutment and fillet dimensions			Calculation factors		
d	d_1 ≈	D_1	B	C	C_1	$r_{1,2}$ min.	$r_{3,4}$ min.	a	d_a max.	d_b min.	r_a max.	e	Y	Y_0
mm									mm			-		
35	54,5	85	21	18	4,5	2	1,5	16	46	44,5	2	0,31	1,9	1,1
40	54,7	72	19	14,5	3,5	1	1	14	46	47,5	1	0,37	1,6	0,9
	57,5	85	18	16	4	1,5	1,5	16	49	48,5	1,5	0,37	1,6	0,9
45	76,1	106	36	30	7	2	1,5	29	56	55	2	0,54	1,1	0,6
55	90,5	127	43	35	8	2,5	2	36	67	67	2,5	0,54	1,1	0,6
65	88,3	116	34	26,5	5,5	1,5	1,5	25	74	75	1,5	0,4	1,5	0,8
	98,7	147	33	28	6	3	2,5	27	84	78	3	0,35	1,7	0,9



8.4 Matched bearings arranged face-to-face

d 25 – 55 mm

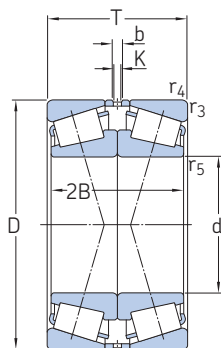

Principal dimensions			Basic load ratings		Fatigue load limit	Speed ratings		Mass	Designation
d	D	T	dynamic	static		Reference speed	Limiting speed		
mm			kN		kN	r/min		kg	–
25	62	36,5	79,9	80	8,65	6 700	11 000	0,55	► 31305/DF
30	62	34,5	85,7	88	9,65	7 500	11 000	0,48	30206/DF
	62	42,5	106	116	12,7	7 500	11 000	0,59	32206/DF
	72	41,5	100	100	11,4	5 600	9 500	0,82	► 31306/DF
35	72	41,5	119	112	12,7	6 700	10 000	0,81	30306/DF
	62	36	89,7	108	11,6	7 000	10 000	0,46	32007 X/DF
	72	48,5	139	156	17	6 300	9 500	0,91	32207/DF
40	72	56	178	212	23,6	6 300	9 500	1,1	33207/DF
	80	45,5	129	134	15,6	5 000	8 500	1,1	31307/DF
	80	45,5	152	150	16,6	6 000	9 000	1,05	30307/DF
45	75	52	167	208	22,8	6 000	9 000	1,05	33108/DF
	80	39,5	130	137	15,3	5 600	8 500	0,87	30208/DF
	90	50,5	156	163	19	4 500	7 500	1,5	31308/DF
50	75	40	123	160	17,6	5 600	8 500	0,71	32009 X/DF
	85	49,5	169	196	22	5 300	8 000	1,2	32209/DF
	100	54,5	194	204	24,5	4 000	6 700	2	31309/DF
55	100	54,5	227	240	28,5	4 500	7 000	2	30309/DF
	80	40	129	176	19,3	5 300	8 000	0,78	32010 X/DF
	80	48	145	204	22,8	5 300	8 000	0,92	33010/DF
55	90	43,5	160	183	20,8	4 800	7 500	1,1	30210/DF
	90	49,5	173	200	22,8	4 800	7 500	1,3	32210/DF
	90	64	243	320	36,5	4 800	7 000	1,75	33210/DF
55	110	58,5	224	240	28,5	3 600	6 000	2,55	31310/DF
	90	46	170	232	26	4 500	7 000	1,15	32011 X/DF
	90	54	191	270	30,5	4 500	7 000	1,35	33011/DF
55	100	45,5	190	212	24	4 500	6 700	1,45	30211/DF
	100	53,5	222	260	30	4 300	6 700	1,75	32211/DF
	120	63	256	275	33,5	3 400	5 600	3,25	31311/DF
	120	63	302	325	39	3 800	5 600	3,25	30311/DF

SKF Explorer bearing

► Popular item

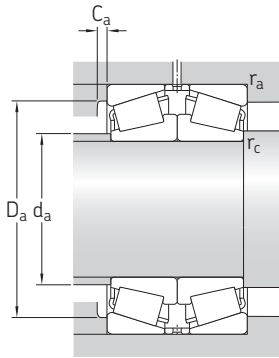

Dimensions				Abutment and fillet dimensions								Calculation factors			
d	2B	b	K	$r_{3,4}$ min.	r_5 min.	d_a max.	D_a min.	D_a max.	C_a min.	r_a max.	r_c max.	e	Y_1	Y_2	Y_0
mm						mm						-			
25	34	6	4	1,5	0,6	34	47	55	3	1,5	0,6	0,83	0,81	1,2	0,8
30	32	3	3	1	0,3	38	53	56	2	1	0,3	0,37	1,8	2,7	1,8
	40	4	3	1	0,3	37	52	56	3	1	0,3	0,37	1,8	2,7	1,8
	38	8	5,5	1,5	0,6	40	55	65	3	1,5	0,6	0,83	0,81	1,2	0,8
	38	6	3	1,5	0,6	41	62	64	3	1,5	0,6	0,31	2,2	3,3	2,2
35	36	5	3	1	0,3	41	54	56	4	1	0,3	0,46	1,5	2,2	1,4
	46	5	3	1,5	0,6	43	61	64	3	1,5	0,6	0,37	1,8	2,7	1,8
	56	7	4	1,5	0,6	43	61	64	5	1,5	0,6	0,35	1,9	2,9	1,8
	42	8	6	1,5	0,6	45	62	72	3	1,5	0,6	0,83	0,81	1,2	0,8
	42	5	3	1,5	0,6	46	70	72	3	1,5	0,6	0,31	2,2	3,3	2,2
40	52	7	4	1,5	0,6	47	65	67	4	1,5	0,6	0,35	1,9	2,9	1,8
	36	4	3	1,5	0,6	49	69	72	3	1,5	0,6	0,37	1,8	2,7	1,8
	46	11	8	1,5	0,6	51	71	82	3	1,5	0,6	0,83	0,81	1,2	0,8
45	40	5	4,5	1	0,3	52	67	68	4	1	0,3	0,4	1,7	2,5	1,6
	46	7	3	1,5	0,6	54	73	77	3	1,5	0,6	0,4	1,7	2,5	1,6
	50	10	8,5	1,5	0,6	57	79	92	4	1,5	0,6	0,83	0,81	1,2	0,8
	50	6	3	1,5	0,6	59	86	92	3	1,5	0,6	0,35	1,9	2,9	1,8
50	40	5	4,5	1	0,3	57	72	73	4	1	0,3	0,43	1,6	2,3	1,6
	48	6	4	1	0,3	57	72	73	4	1	0,3	0,31	2,2	3,3	2,2
	40	4	3	1,5	0,6	59	79	82	3	1,5	0,6	0,43	1,6	2,3	1,6
	46	7	3	1,5	0,6	58	78	82	3	1,5	0,6	0,43	1,6	2,3	1,6
	64	9	5	1,5	0,6	57	77	82	5	1,5	0,6	0,4	1,7	2,5	1,6
	54	10	7,5	2	0,6	63	87	101	4	2	0,6	0,83	0,81	1,2	0,8
55	46	7	4,5	1,5	0,6	63	81	82	4	1,5	0,6	0,4	1,7	2,5	1,6
	54	7	4,5	1,5	0,6	64	81	82	5	1,5	0,6	0,31	2,2	3,3	2,2
	42	6	3	1,5	0,6	64	88	92	4	1,5	0,6	0,4	1,7	2,5	1,6
	50	7	3	1,5	0,6	64	87	92	4	1,5	0,6	0,4	1,7	2,5	1,6
	58	10	7,5	2	0,6	68	94	111	4	2	0,6	0,83	0,81	1,2	0,8
	58	8	4,5	2	0,6	72	104	110	4	2	0,6	0,35	1,9	2,9	1,8



8.4 Matched bearings arranged face-to-face

d 60 – 80 mm

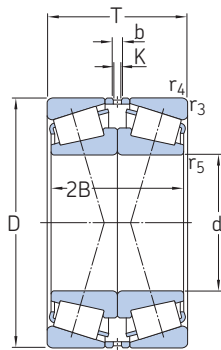

Principal dimensions			Basic load ratings		Fatigue load limit	Speed ratings		Mass	Designation
d	D	T	dynamic	static		Reference speed	Limiting speed		
mm			kN		kN	r/min		kg	–
60	95	46	173	245	27	4 300	6 700	1,2	32012 X/DF
	110	47,5	207	228	26,5	4 000	6 000	1,8	30212/DF
	110	59,5	266	320	37,5	4 000	6 000	2,4	32212/DF
	110	76	354	475	53	3 800	6 000	3,15	33212/DF
	130	67	303	335	40,5	3 000	5 300	4,05	31312/DF
	130	67	357	390	47,5	3 600	5 300	4,1	30312/DF
	130	97	483	585	68	3 200	5 300	6,05	32312/DF
65	100	46	176	255	28	4 000	6 000	1,3	32013 X/DF
	100	54	204	310	34,5	4 000	6 300	1,55	33013/DF
	120	49,5	242	270	32,5	3 600	5 600	2,3	30213/DF
	120	65,5	320	390	45,5	3 600	5 600	3,1	32213/DF
	140	72	348	380	47,5	2 800	4 800	5	31313/DF
70	110	50	214	305	34,5	3 800	5 600	1,75	32014 X/DF
	110	62	273	400	45,5	3 800	5 600	2,2	33014/DF
	120	74	361	500	57	3 600	5 300	3,45	33114/DF
	125	66,5	334	415	49	3 400	5 300	3,3	32214/DF
	150	76	393	440	54	2 600	4 500	6,1	31314/DF
75	115	62	286	455	52	3 600	5 300	2,4	33015/DF
	115	62	286	455	52	3 600	5 300	2,4	33015/DFC240
	125	74	370	530	60	3 400	5 000	3,65	33115/DF
	130	54,5	293	355	41,5	3 400	5 000	2,85	30215/DF
	130	66,5	337	425	49	3 200	5 000	3,4	32215/DF
	130	82	436	600	68	3 200	4 800	4,5	33215/DF
	160	80	438	490	58,5	2 400	4 300	7,15	▶ 31315/DF
	160	116	713	880	102	2 600	4 300	11	32315/DF
80	125	58	288	430	49	3 200	5 000	2,65	32016 X/DF
	130	74	379	560	62	3 200	4 800	3,8	33116/DF
	140	70,5	391	490	57	3 000	4 500	4,25	32216/DF
	140	92	527	750	83	3 000	4 500	5,95	33216/DF
	170	85	473	530	61	2 400	4 000	8,65	31316/DF
	170	123	693	1 000	112	2 600	4 000	13	32316/DF

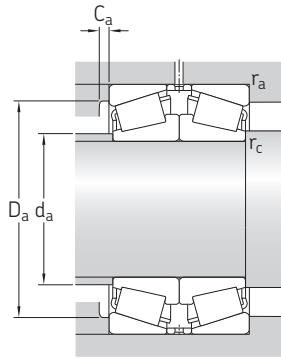

Dimensions				Abutment and fillet dimensions								Calculation factors			
d	2B	b	K	$r_{3,4}$ min.	r_5 min.	d_a max.	D_a min.	D_a max.	C_a min.	r_a max.	r_c max.	e	Y_1	Y_2	Y_0
mm						mm						-			
60	46	7	4,5	1,5	0,6	67	85	87	4	1,5	0,6	0,43	1,6	2,3	1,6
	44	4	3	1,5	0,6	70	96	101	3	1,5	0,6	0,4	1,7	2,5	1,6
	56	7	3	1,5	0,6	69	95	102	4	1,5	0,6	0,4	1,7	2,5	1,6
	76	10	7,5	1,5	0,6	69	93	102	6	1,5	0,6	0,4	1,7	2,5	1,6
	62	13	10	2,5	1	74	103	119	5	2,5	1	0,83	0,81	1,2	0,8
	62	9	6	2,5	1	77	112	119	5	2,5	1	0,35	1,9	2,9	1,8
92	15	6	2,5	1	74	107	119	6	2,5	1	0,35	1,9	2,9	1,8	
65	46	7	4,5	1,5	0,6	73	90	92	4	1,5	0,6	0,46	1,5	2,2	1,4
	54	7	4,5	1,5	0,6	72	89	92	5	1,5	0,6	0,35	1,9	2,9	1,8
	46	5	3	1,5	0,6	78	106	111	4	1,5	0,6	0,4	1,7	2,5	1,6
	62	7	3	1,5	0,6	76	104	111	4	1,5	0,6	0,4	1,7	2,5	1,6
66	12	9	2,5	1	80	111	129	5	2,5	1	0,83	0,81	1,2	0,8	
70	50	6	4,5	1,5	0,6	78	98	101	5	1,5	0,6	0,43	1,6	2,3	1,6
	62	6	4,5	1,5	0,6	78	99	101	5	1,5	0,6	0,28	2,4	3,6	2,5
	74	9	6	1,5	0,6	80	104	111	6	1,5	0,6	0,37	1,8	2,7	1,8
	62	7	3	1,5	0,6	81	108	116	4	1,5	0,6	0,43	1,6	2,3	1,6
70	10	7,5	2,5	1	85	118	139	5	2,5	1	0,83	0,81	1,2	0,8	
75	62	7	5	1,5	0,6	84	104	106	6	1,5	0,6	0,3	2,3	3,4	2,2
	62	7	5	1,5	0,6	84	104	106	6	1,5	0,6	0,3	2,3	3,4	2,2
	74	9	7	1,5	0,6	84	109	116	6	1,5	0,6	0,4	1,7	2,5	1,6
	50	4	3	1,5	0,6	87	115	121	4	1,5	0,6	0,43	1,6	2,3	1,6
	62	7	3	1,5	0,6	85	114	121	4	1,5	0,6	0,43	1,6	2,3	1,6
	82	11	7,5	1,5	0,6	84	111	121	6	1,5	0,6	0,43	1,6	2,3	1,6
74	15	10	2,5	1	91	127	149	5	2,5	1	0,83	0,81	1,2	0,8	
110	15	7,5	2,5	1	92	133	149	7	2,5	1	0,35	1,9	2,9	1,8	
80	58	5	2	1,5	0,6	90	112	116	6	1,5	0,6	0,43	1,6	2,3	1,6
	74	9	6	1,5	0,6	89	114	121	6	1,5	0,6	0,43	1,6	2,3	1,6
	66	4	4,5	2	0,6	91	122	130	5	2	0,6	0,43	1,6	2,3	1,6
	92	13	7,5	2	0,6	90	119	130	7	2	0,6	0,43	1,6	2,3	1,6
	78	15	10	2,5	1	97	134	159	5	2,5	1	0,83	0,81	1,2	0,8
	116	15	7,5	2,5	1	98	142	159	7	2,5	1	0,35	1,9	2,9	1,8



8.4 Matched bearings arranged face-to-face

d 85 – 110 mm

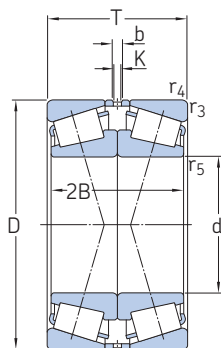

Principal dimensions			Basic load ratings		Fatigue load limit	Speed ratings		Mass	Designation
d	D	T	dynamic	static		Reference speed	Limiting speed		
mm			kN		kN	r/min		kg	–
85	130	58	293	450	51	3 200	4 800	2,8	32017 X/DF
	130	72	382	620	69,5	3 200	4 800	3,5	33017/DF
	150	61	370	440	51	3 000	4 300	4,25	30217/DF
	150	77	451	570	65,5	2 800	4 300	5,4	32217/DF
	150	98	606	850	96,5	2 800	4 300	7,3	33217/DF
	180	89	510	570	64	2 200	3 800	9,9	31317/DF
90	140	64	356	540	62	3 000	4 300	3,65	32018 X/DF
	140	78	457	710	78	3 000	4 500	4,5	33018/DF
	160	65	411	490	57	2 800	4 000	5,2	▶ 30218/DF
	160	85	529	680	76,5	2 600	4 000	6,85	32218/DF
	190	93	486	630	71	1 900	3 400	11,5	▶ 31318/DF
	190	135	835	1 220	132	2 200	3 600	17,5	32318/DF
95	145	64	353	540	61	2 800	4 300	3,8	32019 X/DF
	145	78	467	735	81,5	2 800	4 300	4,7	33019/DF
	170	91	597	780	86,5	2 600	3 800	8,4	▶ 32219/DF
	200	99	539	710	78	1 800	3 400	13,5	▶ 31319/DF
	140	50	252	405	45	2 800	4 300	2,35	32920/DF
	150	64	359	560	62	2 600	4 000	3,9	32020 X/DF
100	180	74	521	640	72	2 400	3 600	7,5	▶ 30220/DF
	180	98	668	880	96,5	2 400	3 600	10	▶ 32220/DF
	215	103	739	980	106	1 900	3 200	17	30320/DF
	215	113	685	930	102	1 700	3 000	18,5	▶ 31320 X/DF
	215	155	1 057	1 560	166	1 900	3 200	26	32320/DF
	105	160	70	426	670	73,5	2 600	3 800	5,05
190		78	571	710	80	2 200	3 400	9	30221/DF
190		106	760	1 020	110	2 200	3 400	12,5	32221/DF
110	170	76	494	780	80	2 400	3 600	6,3	32022 X/DF
	170	76	494	780	80	2 400	3 600	6,3	32022 X/DFC200
	180	112	781	1 250	132	2 200	3 400	11,5	33122/DF
	200	82	561	800	86,5	2 200	3 200	10,5	▶ 30222/DF
	200	112	842	1 140	122	2 200	3 200	14,5	▶ 32222/DF
	240	126	841	1 160	122	1 500	2 800	26	▶ 31322 X/DF
240	169	1 158	1 660	173	1 700	2 800	35	32322/DF	

SKF Explorer bearing

▶ Popular item

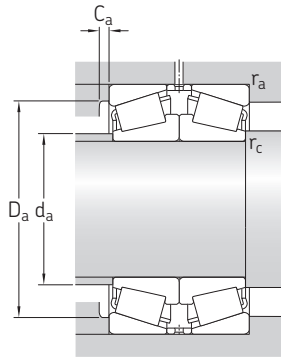

Dimensions				Abutment and fillet dimensions								Calculation factors			
d	2B	b	K	r _{3,4} min.	r ₅ min.	d _a max.	D _a min.	D _a max.	C _a min.	r _a max.	r _c max.	e	Y ₁	Y ₂	Y ₀
mm						mm						-			
85	58	8	4,5	1,5	0,6	95	117	121	6	1,5	0,6	0,44	1,5	2,3	1,4
	72	6	4,5	1,5	0,6	95	118	121	6	1,5	0,6	0,3	2,3	3,4	2,2
	56	6	4,5	2	0,6	97	132	140	5	2	0,6	0,43	1,6	2,3	1,6
	72	10	4,5	2	0,6	97	130	140	5	2	0,6	0,43	1,6	2,3	1,6
	98	10	7,5	2	0,6	96	128	140	7	2	0,6	0,43	1,6	2,3	1,6
	82	15	10	3	1	104	143	167	5	3	1	0,83	0,81	1,2	0,8
90	64	8	6	1,5	0,6	100	125	131	6	1,5	0,6	0,43	1,6	2,3	1,6
	78	8	6	1,5	0,6	101	127	131	7	1,5	0,6	0,27	2,5	3,7	2,5
	60	6	4,5	2	0,6	104	140	150	5	2	0,6	0,43	1,6	2,3	1,6
	80	10	4,5	2	0,6	103	138	150	5	2	0,6	0,43	1,6	2,3	1,6
	86	15	10	3	1	110	151	177	5	3	1	0,83	0,81	1,2	0,8
	128	16	7,5	3	1	109	157	177	7	3	1	0,35	1,9	2,9	1,8
95	64	9	6	1,5	0,6	106	130	136	6	1,5	0,6	0,44	1,5	2,3	1,4
	78	8	4,5	1,5	0,6	105	131	136	7	1,5	0,6	0,28	2,4	3,6	2,5
	86	10	6	2,5	1	109	145	158	5	2,5	1	0,43	1,6	2,3	1,6
	90	15	10	3	1	114	157	187	5	3	1	0,83	0,81	1,2	0,8
100	50	6	3	1,5	0,6	110	131	131	5	1,5	0,6	0,33	2	3	2
	64	10	8	1,5	0,6	110	134	141	6	1,5	0,6	0,46	1,5	2,2	1,4
	68	8	6	2,5	1	116	157	168	5	2,5	1	0,43	1,6	2,3	1,6
	92	8	6	2,5	1	115	154	168	5	2,5	1	0,43	1,6	2,3	1,6
	94	14	7	3	1	128	184	202	6	3	1	0,35	1,9	2,9	1,8
	102	13	10	3	1	121	168	202	7	3	1	0,83	0,81	1,2	0,8
105	146	18	12	3	1	123	177	202	8	3	1	0,35	1,9	2,9	1,8
	70	10	7,5	2	0,6	116	143	149	6	2	0,6	0,44	1,5	2,3	1,4
	72	10	4	2,5	1	123	165	178	5	2,5	1	0,43	1,6	2,3	1,6
	100	11	7,5	2,5	1	121	161	178	6	2,5	1	0,43	1,6	2,3	1,6
110	76	10	7,5	2	0,6	123	152	159	7	2	0,6	0,43	1,6	2,3	1,6
	76	10	7,5	2	0,6	123	152	159	7	2	0,6	0,43	1,6	2,3	1,6
	112	15	7,5	2	0,6	122	155	169	9	2	0,6	0,43	1,6	2,3	1,6
	76	10	7,5	2,5	1	129	174	188	6	2,5	1	0,43	1,6	2,3	1,6
	106	11	7,5	2,5	1	127	170	188	6	2,5	1	0,43	1,6	2,3	1,6
	114	13	10	3	1	136	188	227	8	3	1	0,83	0,81	1,2	0,8
160	11	8	3	1	138	198	227	9	3	1	0,35	1,9	2,9	1,8	



8.4 Matched bearings arranged face-to-face

d 120 – 180 mm

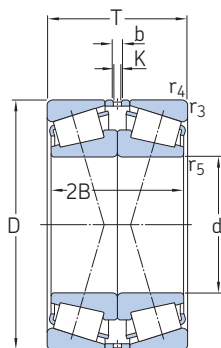

Principal dimensions			Basic load ratings		Fatigue load limit	Speed ratings		Mass	Designation
d	D	T	dynamic	static		Reference speed	Limiting speed		
mm			kN		kN	r/min		kg	–
120	180	76	513	830	85	2 200	3 400	6,75	▶ 32024 X/DF 33024/DF 30224/DF
	180	96	611	1 080	112	2 200	3 400	8,6	
	215	87	716	915	98	2 000	3 000	12,5	
	215	123	983	1 400	143	2 000	3 000	18,5	▶ 32224/DF 30324/DF 31324 X/DF
	260	119	1 031	1 400	146	1 600	2 600	29	
	260	136	992	1 400	146	1 400	2 400	32,5	
	260	181	1 466	2 240	220	1 600	2 600	45	32324/DF
130	180	64	420	735	76,5	2 200	3 200	4,95	32926/DF ▶ 32226/DF 30226/DF
	230	135,5	1 012	1 660	170	1 600	2 800	23	
	230	87,5	774	980	102	1 800	2 800	14	
	280	127,5	1 165	1 600	163	1 400	2 400	35	30326/DF
	280	144	1 110	1 560	160	1 300	2 400	39,5	▶ 31326 X/DF
140	190	64	432	780	80	2 000	3 000	5,2	32928/DF ▶ 32028 X/DF 32228/DF
	210	90	692	1 160	116	1 900	2 800	11	
	250	143,5	1 185	2 000	200	1 500	2 600	29,5	
	250	91,5	773	1 140	116	1 500	2 600	18	30228/DF
	300	154	1 264	1 800	180	1 200	2 200	49	▶ 31328 X/DF
150	225	96	782	1 320	132	1 800	2 600	13,5	▶ 32030 X/DF 30230/DF 32230/DF
	270	98	781	1 120	114	1 400	2 400	22	
	270	154	1 341	2 280	224	1 400	2 400	37,5	
	320	144	1 507	2 120	208	1 300	2 000	52	30330/DF
	320	164	1 427	2 040	200	1 100	2 000	58,5	▶ 31330 X/DF
160	240	102	912	1 560	153	1 600	2 400	16	▶ 32032 X/DF 30232/DF 32232/DF
	290	104	971	1 460	143	1 300	2 200	27,5	
	290	168	1 602	2 800	265	1 300	2 200	48	
170	260	114	1 071	1 830	176	1 500	2 200	21,5	▶ 32034 X/DF 30234/DF 32234/DF
	310	114	1 126	1 730	166	1 200	2 000	34,5	
	310	182	1 843	3 250	300	1 200	2 000	59,5	
180	250	90	746	1 460	137	1 500	2 200	14	32936/DF ▶ 32036 X/DF 30236/DF
	280	128	1 360	2 320	220	1 400	2 200	29	
	320	114	1 079	1 630	160	1 200	2 000	35,5	
	320	182	1 833	3 250	300	1 100	1 900	61	

SKF Explorer bearing

▶ Popular item

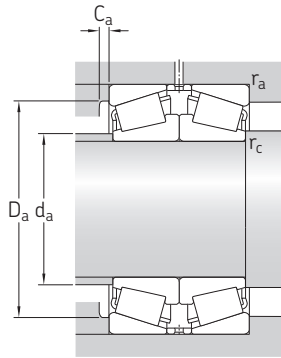

Dimensions				Abutment and fillet dimensions								Calculation factors			
d	2B	b	K	r _{3,4} min.	r ₅ min.	d _a max.	D _a min.	D _a max.	C _a min.	r _a max.	r _c max.	e	Y ₁	Y ₂	Y ₀
mm						mm						-			
120	76	10	7,5	2	0,6	132	161	169	7	2	0,6	0,46	1,5	2,2	1,4
	96	10	7,5	2	0,6	132	160	169	6	2	0,6	0,3	2,3	3,4	2,2
	80	10	7,5	2,5	1	141	187	203	6	2,5	1	0,43	1,6	2,3	1,6
	116	10	7,5	2,5	1	137	181	203	7	2,5	1	0,43	1,6	2,3	1,6
	110	15	8	3	1	153	221	246	8	3	1	0,35	1,9	2,9	1,8
	124	24	14	3	1	146	203	246	9	3	1	0,83	0,81	1,2	0,8
	172	21	7,5	3	1	148	213	246	10	3	1	0,35	1,9	2,9	1,8
130	64	6	4,5	1,5	0,6	141	167	170	6	1,5	0,6	0,33	2	3	2
	128	10	7,5	3	1	146	193	216	7	3	1	0,43	1,6	2,3	1,6
	80	10	7,5	3	1	152	203	216	6	3	1	0,43	1,6	2,3	1,6
	116	17	10	4	1,5	165	239	264	8	4	1,5	0,35	1,9	2,9	1,8
	132	20	15	4	1,5	157	218	264	8	4	1,5	0,83	0,81	1,2	0,8
140	64	9	6	1,5	0,6	151	177	180	6	1,5	0,6	0,35	1,9	2,9	1,8
	90	13	7,5	2	0,6	153	187	199	8	2	0,6	0,46	1,5	2,2	1,4
	136	10	7,5	3	1	159	210	236	8	3	1	0,43	1,6	2,3	1,6
	84	10	7,5	3	1	164	219	236	8	3	1	0,43	1,6	2,3	1,6
	140	20	15	4	1,5	169	235	284	9	4	1,5	0,83	0,81	1,2	0,8
150	96	10	7,5	2,5	1	165	200	212	8	2,5	1	0,46	1,5	2,2	1,4
	90	15	10	3	1	176	234	256	9	3	1	0,43	1,6	2,3	1,6
	146	10	7,5	3	1	171	226	256	8	3	1	0,43	1,6	2,3	1,6
	130	19	10	4	1,5	189	273	303	9	4	1,5	0,35	1,9	2,9	1,8
	150	20	15	4	1,5	181	251	304	9	4	1,5	0,83	0,81	1,2	0,8
160	102	11	9	2,5	1	176	213	227	8	2,5	1	0,46	1,5	2,2	1,4
	96	15	10	3	1	190	252	276	7	3	1	0,43	1,6	2,3	1,6
	160	10	7,5	3	1	183	242	276	10	3	1	0,43	1,6	2,3	1,6
170	114	15	10	2,5	1	188	230	247	10	2,5	1	0,44	1,5	2,3	1,4
	104	16	10	4	1,5	203	269	293	8	4	1,5	0,43	1,6	2,3	1,6
	172	15	10	4	1,5	196	259	293	10	4	1,5	0,43	1,6	2,3	1,6
180	90	10	7,5	2	0,6	194	225	238	8	2	0,6	0,48	1,4	2,1	1,4
	128	15	10	2,5	1	200	247	267	10	2,5	1	0,43	1,6	2,3	1,6
	104	15	10	4	1,5	212	278	303	8	4	1,5	0,46	1,5	2,2	1,4
	172	16	12	4	1,5	205	267	303	10	4	1,5	0,46	1,5	2,2	1,4



8.4 Matched bearings arranged face-to-face

d 190 – 360 mm

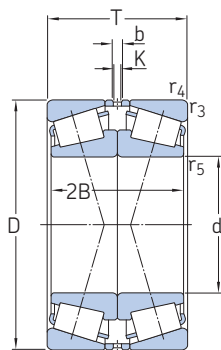

Principal dimensions			Basic load ratings		Fatigue load limit	Speed ratings		Mass	Designation
d	D	T	dynamic	static		Reference speed	Limiting speed		
mm			kN		kN	r/min		kg	–
190	260	90	760	1 530	143	1 400	2 200	14,5	32938/DF
	290	128	1 381	2 400	224	1 300	2 000	30,5	▶ 32038 X/DF
	290	128	1 381	2 400	224	1 300	2 000	30,5	▶ 32038 X/L4BDF
	340	120	1 308	2 000	190	1 100	1 800	42,5	30238/DF
200	310	140	1 372	2 750	255	1 100	1 900	39	▶ 32040 X/DF
	360	128	1 448	2 240	212	1 000	1 700	52	30240/DF
	360	208	2 229	4 000	360	1 000	1 700	88	▶ 32240/DF
220	300	102	1 030	2 000	183	1 200	1 900	21	32944/DF
	340	152	1 637	3 350	300	1 000	1 700	51	▶ 32044 X/DF
	400	144	1 816	2 800	255	950	1 600	72	30244/DF
	400	228	2 949	5 400	465	900	1 500	124	▶ 32244/DF
240	320	102	1 069	2 160	193	1 200	1 700	22,5	32948/DF
	360	152	1 695	3 550	315	950	1 600	54,5	▶ 32048 X/DF
	440	254	3 300	6 550	550	1 000	1 500	172	32248/DF
260	400	174	2 127	4 400	380	850	1 400	79	▶ 32052 X/DF
	480	274	4 013	7 350	600	750	1 200	213	32252/DF
280	420	174	2 208	4 750	400	800	1 300	84	▶ 32056 X/DF
	500	274	2 410	7 800	620	700	1 200	226	32256/DF
300	460	200	2 818	6 000	490	750	1 200	119	32060 X/DF
	540	280	2 935	9 500	735	630	1 100	290	32260/DF
320	440	152	1 982	4 650	390	750	1 200	69	32964/DF
	480	200	2 852	6 200	500	700	1 100	104	32064 X/DF
340	460	152	1 995	4 800	390	700	1 200	73	32968/DF
360	480	152	2 043	5 100	405	670	1 100	302	32972/DF

8.4

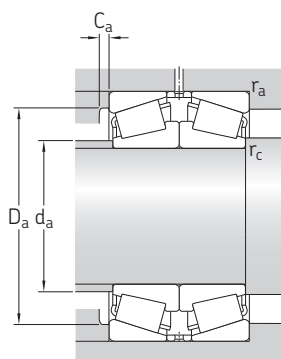

Dimensions				Abutment and fillet dimensions								Calculation factors			
d	2B	b	K	$r_{3,4}$ min.	r_5 min.	d_a max.	D_a min.	D_a max.	C_a min.	r_a max.	r_c max.	e	Y_1	Y_2	Y_0
mm						mm						-			
190	90	10	7,5	2	0,6	205	235	248	8	2	0,6	0,48	1,4	2,1	1,4
	128	15	10	2,5	1	210	257	276	10	2,5	1	0,44	1,5	2,3	1,4
	128	15	10	2,5	1	210	257	276	10	2,5	1	0,44	1,5	2,3	1,4
	110	16	10	4	1,5	225	298	323	8	4	1,5	0,43	1,6	2,3	1,6
200	140	15	10	2,5	1	222	273	296	11	2,5	1	0,43	1,6	2,3	1,6
	116	19	12	4	1,5	237	315	343	9	4	1,5	0,43	1,6	2,3	1,6
	196	15	10	4	1	231	302	343	11	4	1	0,4	1,7	2,5	1,6
220	102	10	7,5	2,5	1	235	275	286	9	2,5	1	0,43	1,6	2,3	1,6
	152	20	15	3	1	244	300	325	12	3	1	0,43	1,6	2,3	1,6
	130	15	10	4	1,5	259	348	382	10	4	1,5	0,43	1,6	2,3	1,6
	216	25	18	4	1,5	253	334	382	13	4	1,5	0,43	1,6	2,3	1,6
240	102	12	7,5	2,5	1	255	294	306	9	2,5	1	0,46	1,5	2,2	1,4
	152	20	15	3	1	262	318	345	12	3	1	0,46	1,5	2,2	1,4
	240	20	16	4	1,5	276	365	420	7	3	1,5	0,43	1,6	2,3	1,6
260	174	25	15	4	1,5	288	352	382	14	4	1,5	0,43	1,6	2,3	1,6
	260	35	16	5	1,5	303	401	458	10	1,5	1,5	0,43	1,6	2,3	1,6
280	174	20	15	4	1,5	306	370	402	14	4	1,5	0,46	1,5	2,2	1,4
	260	20	16	5	1,5	319	418	478	10	4	1,5	0,44	1,5	2,3	1,4
300	200	20	12	4	1,5	330	404	440	10	1,5	1,5	0,43	1,6	2,3	1,6
	298	36	18	5	1,5	343	453	518	10	4	1,5	0,43	1,6	2,3	1,6
320	152	17	15	3	1	343	402	424	9	1	1	0,43	1,6	2,3	1,6
	200	20	16	4	1,5	350	424	460	15	1,5	1,5	0,46	1,5	2,2	1,4
340	152	18	16	3	1	361	421	444	10	1	1	0,44	1,5	2,3	1,4
360	152	22	16	3	1	380	439	464	10	2,5	1	0,46	1,5	2,2	1,4



8.5 Matched bearings arranged back-to-back

d 35 – 90 mm

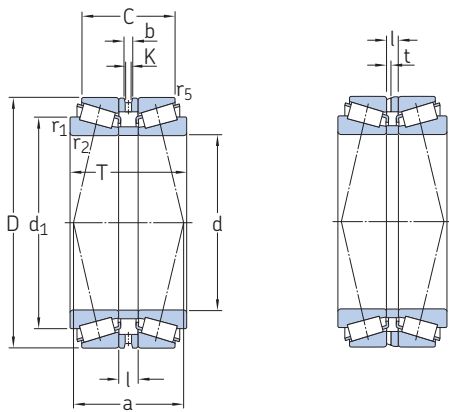

$l \geq 7 \text{ mm}$

$l < 7 \text{ mm}$

Principal dimensions			Basic load ratings		Fatigue load limit	Speed ratings		Mass	Designation
d	D	T	dynamic	static	P_u	Reference speed	Limiting speed		
mm			kN		kN	r/min		kg	–
35	72	64	178	212	23,6	6 300	9 500	1,15	33207T64/DB
40	68	41,5	111	143	15,3	6 300	9 500	0,58	32008T41.5 X/DB
	90	72	182	190	21,6	5 300	8 000	1,9	30308T72/DB
45	100	62,5	194	204	24,5	4 000	6 700	2,1	31309T62.5/DB
50	80	50	129	176	19,3	5 300	8 000	0,86	32010T50 X/DB
	90	67,5	173	200	22,8	4 800	7 500	1,5	32210T67.5/DB
55	90	59	191	270	30,5	4 500	7 000	1,4	33011T59/DB
	95	88	232	310	35,5	4 500	6 700	2,1	33111T88/DB
60	95	65	173	245	27	4 300	6 700	1,45	32012T65 X/DB
	110	53	207	228	26,5	4 000	6 000	1,9	30212T53/DB
65	100	53	176	255	28	4 000	6 000	1,35	32013T53 X/DB
	100	60	204	310	34,5	4 000	6 300	1,6	33013T60/DB
	140	82	411	455	55	3 200	4 800	5,3	30313T82/DB
70	110	63	214	305	34,5	3 800	5 600	1,9	32014T63 X/DB
	110	108,8	273	400	45,5	3 800	5 600	3,05	33014T108.8/DB
	125	59	267	310	36	3 400	5 300	2,7	30214T59/DB
	150	84	465	520	62	3 000	4 500	6,3	30314T84/DB
75	130	70	293	355	41,5	3 400	5 000	3,2	30215T70/DB
	130	78	337	425	49	3 200	5 000	3,7	32215T78/DB
80	140	78	391	490	57	3 000	4 500	4,4	32216T78/DB
85	130	66	293	450	51	3 200	4 800	2,85	32017T66 X/DB
	150	87	451	570	65,5	2 800	4 300	5,65	32217T87/DB
	150	145	606	850	96,5	2 800	4 300	9	33217T145/DB
	180	132	858	1 060	120	2 600	3 800	14,5	32317T132/DB
	180	133,19	510	570	64	2 200	3 800	12	31317T133.19/DB
90	150	104	532	780	85	2 800	4 300	6,7	33118T104/DB

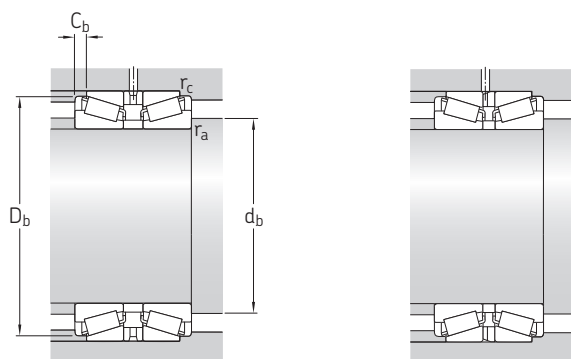

Dimensions										Abutment and fillet dimensions					Calculation factors			
d	d ₁ ≈	C	l	b	K	t	r _{1,2} min.	r ₅ min.	a	d _b min.	D _b min.	C _b min.	r _a max.	r _c max.	e	Y ₁	Y ₂	Y ₀
mm										mm					-			
35	53,4	52	8	4	1,5	-	1,5	0,6	44	43,5	68	6	1,5	0,6	0,35	1,9	2,9	1,8
40	54,7 62,5	32,5 61,5	3,5 21,5	- 9	- 6	1,5 -	1 2	0,3 0,6	33 60	47,5 49,5	65 82	4,5 5	1 2	0,3 0,6	0,37 0,35	1,8 1,9	2,7 2,9	1,8 1,8
45	74,7	44	8	5	3	-	2	0,6	70	55	95	9	2	0,6	0,83	0,81	1,2	0,8
50	65,9 68,6	41 56	10 18	6 10	4 2	- -	1 1,5	0,3 0,6	45 60	58 59	77 85	4,5 5,5	1 1,5	0,3 0,6	0,43 0,43	1,6 1,6	2,3 2,3	1,6 1,6
55	73,1 75,1	47 74	5 28	- 16	- 8	2 -	1,5 1,5	0,6 0,6	43 72	64 64	86 91	6 7	1,5 1,5	0,6 0,6	0,31 0,37	2,2 1,8	3,3 2,7	2,2 1,8
60	77,8 80,9	54 43,5	19 5,5	7 -	4,5 -	- 2	1,5 2	0,6 0,6	60 49	69 70	91 103	5,5 4,5	1,5 2	0,6 0,6	0,43 0,4	1,6 1,7	2,3 2,5	1,6 1,6
65	83,3 82,6 98,7	42 48 66	7 6 10	4 - 4	3 - 2	- 2 -	1,5 1,5 3	0,6 0,6 1	51 48 65	74 74 78	97 96 130	5,5 6 8	1,5 1,5 3	0,6 0,6 1	0,46 0,35 0,35	1,5 1,9 1,9	2,2 2,9 2,9	1,4 1,8 1,8
70	89,9 88,9 94	51 97,8 48,5	13 46,8 6,5	3 10 -	2 4,5 -	- - 2	1,5 1,5 2	0,6 0,6 0,6	60 92 57	80 80 81	105 105 118	6 5,5 5	1,5 1,5 2	0,6 0,6 0,6	0,43 0,28 0,43	1,6 2,4 1,6	2,3 3,6 2,3	1,6 2,5 1,6
	105	68	8	4	3	-	3	1	66	83	140	8	3	1	0,35	1,9	2,9	1,8
75	99,8 100	59,5 65,5	15,5 11,5	8,6 7	5 2	- -	2 2	0,6 0,6	69 70	86 86	124 125	5 6	2 2	0,6 0,6	0,43 0,43	1,6 1,6	2,3 2,3	1,6 1,6
80	106	63,5	7,5	4	3	-	2,5	0,6	68	92	134	7	2,5	0,6	0,43	1,6	2,3	1,6
85	108 113 117	52 70 121	8 10 47	4 6 26	3 3 14	- - -	1,5 2,5 2,5	0,6 0,6 0,6	64 76 120	95 97 97	125 142 144	7 8,5 12	1,5 2,5 2,5	0,6 0,6 0,6	0,44 0,43 0,43	1,5 1,6 1,6	2,3 2,3 2,3	1,4 1,6 1,6
	127 131	103 100,19	5 44,19	- 15	- 10	3 -	4 4	1 1	88 152	101 101	167 169	16,5 14,5	4 4	1 1	0,35 0,83	1,9 0,81	2,9 1,2	1,8 0,8
90	120	84	14	8	4	-	2,5	0,6	83	102	144	10	2,5	0,6	0,4	1,7	2,5	1,6



8.5 Matched bearings arranged back-to-back

d 95 – 160 mm

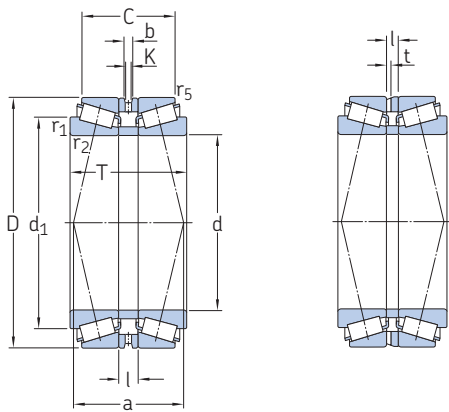

$l \geq 7 \text{ mm}$

$l < 7 \text{ mm}$

Principal dimensions			Basic load ratings		Fatigue load limit	Speed ratings		Mass	Designation
d	D	T	dynamic	static	P_u	Reference speed	Limiting speed		
mm			kN		kN	r/min		kg	–
95	170	105	597	780	86,5	2 600	3 800	9	32219T105/DB
100	150	88	477	765	83	2 800	4 000	5	33020T88/DB
	180	100	521	640	72	2 400	3 600	8,85	30220T100/DB
	180	107	668	880	96,5	2 400	3 600	10,5	32220T107/DB
105	180	135	912	1 320	140	2 400	3 600	14	33220T135/DB
	215	125	685	930	102	1 700	3 000	19	31320T125 X/DB
105	190	88	571	710	80	2 200	3 400	9,35	30221T88/DB
110	170	84	494	780	80	2 400	3 600	6,5	32022T84 X/DB
	200	122	842	1 140	122	2 200	3 200	15	32222T122/DB
	240	140	841	1 160	122	1 500	2 800	26	31322T140 X/DB
120	215	133	716	915	98	2 000	3 000	16	30224T133/DB
130	180	76	420	735	76,5	2 200	3 200	5,25	32926T76/DB
	200	102	666	1 080	110	2 000	3 000	10,5	32026T102 X/DB
	230	142	1 012	1 660	170	1 600	2 800	23	32226T142/DB
130	280	142	1 165	1 600	163	1 400	2 400	36,5	30326T142/DB
	280	164	1 110	1 560	160	1 300	2 400	41	31326T164 X/DB
140	210	130	692	1 160	116	1 900	2 800	13	32028T130 X/DB
	250	102	773	1 140	116	1 500	2 600	18,5	30228T102/DB
	250	106	773	1 140	116	1 500	2 600	19	30228T106/DB
140	250	158	1 185	2 000	200	1 500	2 600	30	32228T158/DB
	300	170	1 264	1 800	180	1 200	2 200	49	31328T170 X/DB
150	225	112	782	1 320	132	1 800	2 600	14	32030T112 X/DB
	225	132	836	1 730	170	1 700	2 600	17	33030T132/DB
	270	164	1 341	2 280	224	1 400	2 400	37,5	32230T164/DB
150	270	168	781	1 120	114	1 400	2 400	32	30230T168/DB
	320	179	1 427	2 040	200	1 100	2 000	58,5	31330T179 X/DB
160	290	114	971	1 460	143	1 300	2 200	28	30232T114/DB
	290	179	1 602	2 800	265	1 300	2 200	49	32232T179/DB

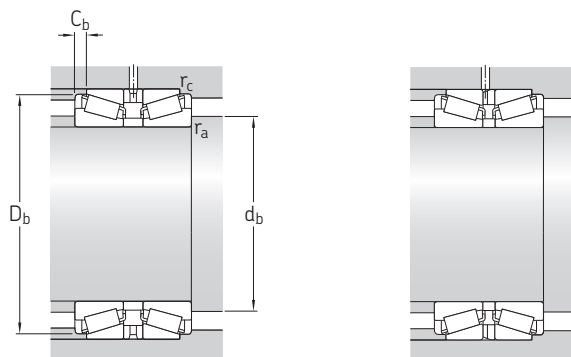

Dimensions										Abutment and fillet dimensions					Calculation factors			
d	d ₁ ≈	C	l	b	K	t	r _{1,2} min.	r ₅ min.	a	d _b min.	D _b min.	C _b min.	r _a max.	r _c max.	e	Y ₁	Y ₂	Y ₀
mm										mm					-			
95	128	88	14	4,5	3	-	3	1	91	109	161	8,5	3	1	0,43	1,6	2,3	1,6
100	122	75	10	6	3	-	2	0,6	68	111	143	6,5	2	0,6	0,28	2,4	3,6	2,5
	134	84	26	9	3	-	3	1	97	114	168	8	3	1	0,43	1,6	2,3	1,6
	136	87	9	4	3	-	3	1	91	114	171	10	3	1	0,43	1,6	2,3	1,6
	139	105	9	4	3	-	3	1	99	114	172	15	3	1	0,4	1,7	2,5	1,6
	158	82	12	7	3	-	4	1	142	116	202	21,5	4	1	0,83	0,81	1,2	0,8
105	143	70	10	5	2	-	3	1	85	119	177	9	3	1	0,43	1,6	2,3	1,6
110	140	66	8	4,5	3	-	2,5	0,6	80	123	163	9	2,5	0,6	0,43	1,6	2,3	1,6
	151	102	10	5	3	-	3	1	103	124	190	10	3	1	0,43	1,6	2,3	1,6
	176	90	14	8	6	-	4	1	159	127	224	25	4	1	0,83	0,81	1,2	0,8
120	161	114	46	10	7,5	-	3	1	131	134	201	9,5	3	1	0,43	1,6	2,3	1,6
130	153	62	12	7	3	-	2	0,6	75	142	173	7	2	0,6	0,33	2	3	2
	165	80	12	8	6	-	2,5	0,6	98	143	192	11	2,5	0,6	0,43	1,6	2,3	1,6
	176	114,5	6,5	-	-	3	4	1	118	147	219	13,5	4	1	0,43	1,6	2,3	1,6
	192	112,5	14,5	6	3	-	5	1,5	116	149	255	14,5	5	1,5	0,35	1,9	2,9	1,8
	204	108	20	8	6	-	5	1,5	188	149	261	28	5	1,5	0,83	0,81	1,2	0,8
140	175	108	40	10,7	6	-	2,5	0,6	131	154	202	11	2,5	0,6	0,46	1,5	2,2	1,4
	187	82,5	10,5	5,5	4	-	4	1	105	157	234	9,5	4	1	0,43	1,6	2,3	1,6
	187	86,5	14,5	5,5	4	-	4	1	109	157	234	9,5	4	1	0,43	1,6	2,3	1,6
	191	130,5	14,5	4	3	-	4	1	134	157	238	13,5	4	1	0,43	1,6	2,3	1,6
	220	110	16	7,5	6	-	5	1,5	196	160	280	30	5	1,5	0,83	0,81	1,2	0,8
150	187	88	16	4	3	-	3	1	114	165	216	12	3	1	0,46	1,5	2,2	1,4
	188	106	14	8	3	-	3	1	110	165	217	13	3	1	0,37	1,8	2,7	1,8
	205	130	10	5	2	-	4	1	138	167	254	17	4	1	0,43	1,6	2,3	1,6
	200	146	70	6	4,5	-	4	1	171	167	250	11	4	1	0,43	1,6	2,3	1,6
	234	115	15	8	6	-	5	1,5	207	170	300	32	5	1,5	0,83	0,81	1,2	0,8
160	215	90	10	4,5	3	-	4	1	118	177	269	12	4	1	0,43	1,6	2,3	1,6
	222	145	11	6	4,5	-	4	1	150	178	274	17	4	1	0,43	1,6	2,3	1,6



8.5 Matched bearings arranged back-to-back

d 170 – 320 mm

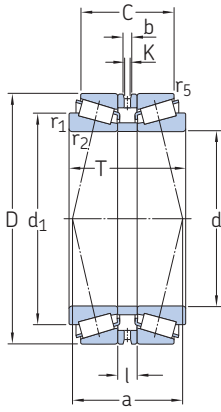

Principal dimensions			Basic load ratings		Fatigue load limit	Speed ratings		Mass	Designation
d	D	T	dynamic	static		Reference speed	Limiting speed		
mm			kN		kN	r/min		kg	–
170	310	194	1 843	3 250	300	1 200	2 000	60	32234T194/DB
180	250	103	746	1 460	137	1 500	2 200	14,5	32936T103/DB
	280	138	1 360	2 320	220	1 400	2 200	29,5	32036T138 X/DB
	320	192	1 833	3 250	300	1 100	1 900	61	32236T192/DB
190	260	102	760	1 530	143	1 400	2 200	15	32938T102/DB
	340	136	1 308	2 000	190	1 100	1 800	44,5	30238T136/DB
200	360	288	2 229	4 000	360	1 000	1 700	105	32240T228/DB
220	340	164	1 637	3 350	300	1 000	1 700	51,5	32044T164 X/DB
	400	248	2 949	5 400	465	900	1 500	126	32244T248/DB
240	320	114	1 069	2 160	193	1 200	1 700	23,5	32948T114/DB
	360	164	1 695	3 550	315	950	1 600	54,5	32048T164 X/DB
260	400	189	2 127	4 400	380	850	1 400	79,5	32052T189 X/DB
280	380	170	1 629	3 350	285	950	1 400	47,5	32956T170/DB
320	480	220	2 852	6 200	500	700	1 100	128	32064T220 X/DB

8.5



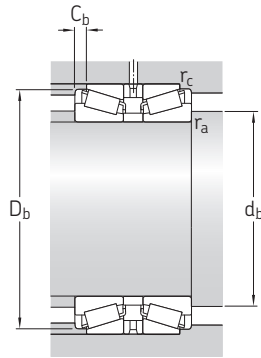

Dimensions										Abutment and fillet dimensions					Calculation factors			
d	d ₁ ≈	C	l	b	K	t	r _{1,2} min.	r ₅ min.	a	d _b min.	D _b min.	C _b min.	r _a max.	r _c max.	e	Y ₁	Y ₂	Y ₀
mm										mm					-			
170	238	154	12	6	4,5	-	5	1,5	162	190	294	20	5	1,5	0,43	1,6	2,3	1,6
180	216	81	13	7,5	5	-	2,5	0,6	120	194	241	11	2,5	0,6	0,48	1,4	2,1	1,4
	230	106	10	4	3	-	3	1	128	196	267	16	3	1	0,43	1,6	2,3	1,6
	247	152	10	5	2	-	5	1,5	165	200	303	20	5	1,5	0,46	1,5	2,2	1,4
190	227	80	12	6,5	5	-	2,5	0,6	122	204	251	11	2,5	0,6	0,48	1,4	2,1	1,4
	254	108	16	9	4,5	-	5	1,5	142	210	318	14	5	1,5	0,43	1,6	2,3	1,6
200	274	244	80	13,5	8	-	4	1	245	218	340	22	4	1	0,4	1,7	2,5	1,6
220	280	126	12	6,4	5	-	4	1	156	238	326	19	4	1	0,43	1,6	2,3	1,6
	306	200	20	8	5	-	5	1,5	210	241	379	24	5	1,5	0,43	1,6	2,3	1,6
240	280	90	12	7	4,5	-	3	1	140	256	311	12	3	1	0,46	1,5	2,2	1,4
	300	126	12	6	4,5	-	4	1	167	259	346	19	4	1	0,46	1,5	2,2	1,4
260	328	145	15	9	6	-	5	1,5	183	281	383	22	5	1,5	0,43	1,6	2,3	1,6
280	329	139	43	20	10	-	3	1	191	297	368	15,5	3	1	0,43	1,6	2,3	1,6
320	399	168	20	10	6	-	5	1,5	226	342	461	26	4	5	0,46	1,5	2,2	1,4



8.6 Matched bearings arranged in tandem

d 45 – 80 mm

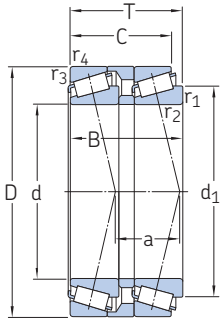

Principal dimensions			Basic load ratings		Fatigue load limit	Speed ratings		Mass	Designation
d	D	T	dynamic	static		Reference speed	Limiting speed		
mm			kN		kN	r/min		kg	–
45	95	62	189	224	25,5	4 000	7 000	2,05	T7FC 045T62/DTC10
50	105	69	229	275	31,5	3 600	6 300	2,75	T7FC 050T69/DTC10
55	115	73	266	325	39	3 400	5 600	3,5	T7FC 055T73/DTC10
60	125	80	325	405	49	3 000	5 300	4,55	T7FC 060T80/DTC15
65	130	80	332	430	51	3 000	5 000	4,8	T7FC 065T80/DTC15
80	160	98	480	630	71	2 400	4 000	8,8	T7FC 080T98/DTC20

8.6



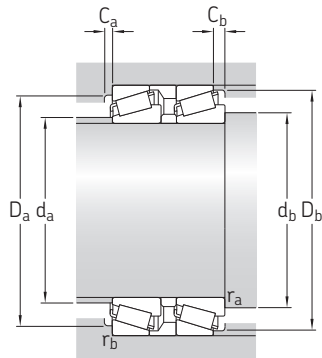

Dimensions							Abutment and fillet dimensions							Calculation factors				
d	d_1 ≈	B	C	$r_{1,2}$ min.	$r_{3,4}$ min.	a	d_a max.	d_b min.	D_a min.	D_a max.	D_b min.	C_a min.	C_b min.	r_a max.	r_b max.	e	Y	Y_0
mm							mm							-				
45	73,4	59,5	53	2,5	2,5	33	54	56	71	85	91	3	9	2,5	2,5	0,88	0,68	0,4
50	81,3	66	59	3	3	37	60	62	78	94	100	4	10	3	3	0,88	0,68	0,4
55	89,5	70	62,5	3	3	39	66	68	86	104	109	4	10,5	3	3	0,88	0,68	0,4
60	97,2	76,5	69	3	3	43	72	73	94	113	119	4	11	3	3	0,83	0,72	0,4
65	102	76,5	69	3	3	43	77	78	98	118	124	4	11	3	3	0,88	0,68	0,4
80	125	94	84	3	3	53	94	94	121	148	152	5	14	3	3	0,88	0,68	0,4



8.7 Double row tapered roller bearings, TDO design

d 101,6 – 355,6 mm

4 – 14 in.

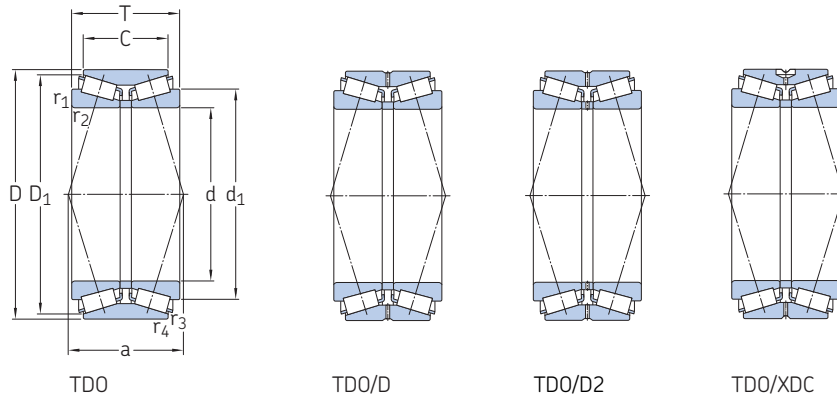

Principal dimensions				Basic load ratings		Fatigue load limit	Mass	Designation	Design variant/feature
d	D	T	C	C	C ₀				
mm/in.				kN		kN	kg	–	–
101,6 4	146,05 5.75	49,212 1.9375	38,94 1.5331	267	375	40,5	2,45	BT2B 332767 A	TDO/D
155 6.1024	200 7.874	66 2.5984	54 2.126	312	620	60	4,85	BT2B 328957	TDO/D
228,6 9	488,95 19.25	254 10	152,4 6	3 143	4 500	390	205	331945	TDO/D
254 10	422,275 16.625	173,038 6.8125	128,66 5.0654	2 393	4 050	355	87,5	BT2B 328615	TDO/D
	422,275 16.625	178,592 7.0312	139,7 5.5	2 393	4 050	355	97,5	BT2B 331782	TDO/D
260 10.2362	440 17.3228	144 5.6693	128 5.0394	1 994	3 450	305	86,5	617479 B	TDO/XDC
	480 18.8976	284 11.1811	220 8.6614	4 330	7 350	600	210	BT2B 328130	TDO
300 11.811	500 19.6851	203 7.9921	152 5.9843	2 992	5 100	425	140	BT2B 328383/HA1	TDO/D2
300,038 11.8125	422,275 16.625	174,625 6.875	136,525 5.375	2 177	4 750	400	71,5	BT2B 332504/HA2	TDO/XDC
317,5 12.5	447,675 17.625	180,975 7.125	146,05 5.75	2 521	5 400	440	84	BT2B 332516 A/HA1	TDO/XDC
330,2 13	482,6 19	177,8 7	127 5	1 293	5 000	415	100	BT2B 332845/HA2	TDO/D
333,375 13.125	469,9 18.5	190,5 7.5	152,4 6	2 642	5 700	465	98	331775 B	TDO/XDC
340 13.3858	460 18.1102	160 6.2992	128 5.0394	2 196	4 900	400	71	BT2B 332830	TDO/D
342,9 13.5	533,4 21	174,625 6.875	123,825 4.875	2 540	4 400	365	130	BT2B 332802 A	TDO/D
346,075 13.625	488,95 19.25	200,025 7.875	158,75 6.25	2 835	6 300	510	110	331981	TDO/D
355,6 14	444,5 17.5	136,525 5.375	111,125 4.375	1 353	3 650	300	46	BT2B 332505/HA2	TDO/XDC
	501,65 19.75	155,575 6.125	107,95 4.25	1 976	4 250	345	87	BT2B 332506/HA2	TDO/D



Dimensions			Calculation factors							Comparative data ¹⁾		Thrust factor K
d	d ₁ ≈	D ₁ ≈	r _{1,2} min.	r _{3,4} min.	a	e	Y ₁	Y ₂	Y ₀	Load ratings radial C _F	axial C _{Fa}	
mm/in.	mm					–				kN		–
101,6 4	106	142	1,5	0,8	54	0,37	1,8	2,7	1,8	71	25,2	1,61
155 6.1024	161	189	1,5	0,6	75	0,35	1,9	2,9	1,8	83	28,9	1,66
228,6 9	400	456	6,4	1,5	326	0,94	0,72	1,07	0,7	780	726	0,62
254 10	331	400	6,8	1,5	153	0,33	2	3	2	585	193	1,76
	331	400	6,8	1,5	158	0,33	2	3	2	585	193	1,76
260 10.2362	341	406	5	1,5	156	0,37	1,8	2,7	1,8	490	179	1,56
	366	454	5	1,5	233	0,43	1,6	2,3	1,6	1 080	456	1,36
300 11.811	387	465	5	1,5	205	0,4	1,7	2,5	1,6	735	297	1,43
300,038 11.8125	357	403	6,4	1,5	162	0,33	2	3	2	540	176	1,73
317,5 12.5	376	428	3,5	1,5	170	0,33	2	3	2	620	204	1,74
330,2 13	401	454	3,3	1,5	184	0,4	1,7	2,5	1,6	585	225	1,49
333,375 13.125	398	452	6,4	1,5	180	0,33	2	3	2	655	217	1,73
340 13.3858	394	442	3	1	161	0,31	2,2	3,3	2,2	540	167	1,86
342,9 13.5	422	496	4,8	1,5	180	0,33	2	3	2	620	202	1,76
346,075 13.625	413	467	6,4	1,5	186	0,33	2	3	2	695	230	1,74
355,6 14	398	428	3,5	1,5	151	0,31	2,2	3,3	2,2	325	100	1,9
	431	481	6,4	1,5	197	0,44	1,5	2,3	1,4	480	207	1,33

¹⁾ For additional information → Comparative load ratings for double row tapered roller bearings, page 685

8.7 Double row tapered roller bearings, TDO design

d 360 – 431,8 mm

14.1732 – 17 in.

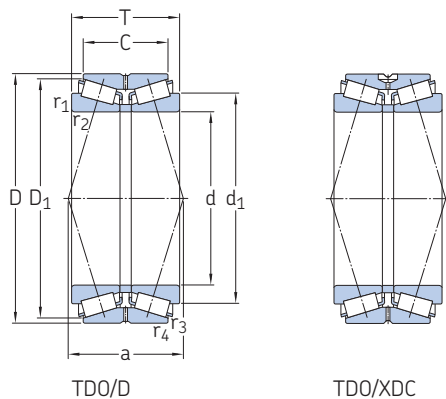

Principal dimensions				Basic load ratings		Fatigue load limit	Mass	Designation	Design variant/feature
d	D	T	C	dynamic	static				
mm/in.				C	C ₀	P _u	kg	–	–
360 14.1732	480 18.8976	160 6.2992	128 5.0394	2 211	5 000	405	73	BT2B 332831	TDO/D
368,249 14.498	523,875 20.625	214,312 8.4375	169,862 6.6875	3 380	7 500	585	140	BT2B 332603/HA1	TDO/D
368,3 14.5	596,9 23.5	203,2 8	133,35 5.25	3 270	5 850	465	188	BT2B 332754	TDO/XDC
371,475 14.625	501,65 19.75	155,575 6.125	107,95 4.25	1 976	4 250	345	76,5	331606 A	TDO/XDC
380 14.9606	520 20.4725	148 5.8268	112 4.4095	2 289	4 500	365	80	BT2B 328020	TDO/D
384,175 15.125	546,1 21.5	222,25 8.75	177,8 7	3 724	8 300	640	161	331197 A	TDO/D
406,4 16	539,75 21.25	142,875 5.625	101,6 4	1 817	4 400	345	82,5	BT2B 328389	TDO/XDC
415,925 16.375	590,55 23.25	244,475 9.625	193,675 7.625	4 175	9 650	720	205	331656	TDO/XDC
431,8 17	571,5 22.5	155,575 6.125	111,125 4.375	1 145	5 100	405	100	BT2B 332604/HA1	TDO/D
	571,5 22.5	192,088 7.5625	146,05 5.75	2 847	6 950	530	127	BT2B 332237 A/HA1	TDO/XDC

8.7





Dimensions			Calculation factors							Comparative data ¹⁾		Thrust factor K
d	d ₁ ≈	D ₁ ≈	r _{1,2} min.	r _{3,4} min.	a	e	Y ₁	Y ₂	Y ₀	Load ratings radial C _F	axial C _{Fa}	
mm/in.	mm					–				kN		–
360 14.1732	414	462	3	1	169	0,33	2	3	2	540	175	1,77
368,249 14.498	438	499	6,4	1,5	196	0,33	2	3	2	830	273	1,76
368,3 14.5	469	552	9,7	2,3	220	0,4	1,7	2,5	1,6	800	330	1,41
371,475 14.625	431	481	6,4	1,5	198	0,44	1,5	2,3	1,4	480	207	1,33
380 14.9606	438	497	4	1,5	162	0,3	2,3	3,4	2,2	560	167	1,92
384,175 15.125	457	521	6,4	0,6	205	0,33	2	3	2	915	301	1,76
406,4 16	473	516	6,4	1,5	215	0,48	1,4	2,1	1,4	440	207	1,23
415,925 16.375	497	563	6,4	1,5	225	0,33	2	3	2	1 040	332	1,76
431,8 17	500	547	3,3	1,5	254	0,54	1,25	1,8	1,3	510	280	1,07
	500	550	6,4	1,5	234	0,44	1,5	2,3	1,4	695	301	1,33

¹⁾ For additional information → Comparative load ratings for double row tapered roller bearings, page 685

8.8 Double row tapered roller bearings, TDI design

d 203,2 – 343,052 mm

8 – 13.506 in.

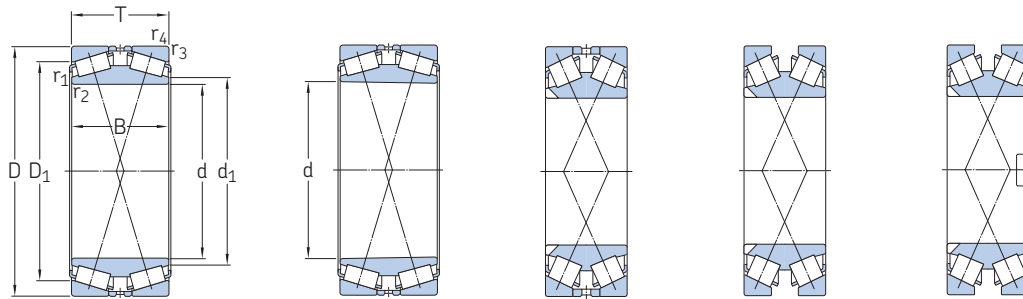

TDI/Y2

TDIT/Y2

TDIS/N

TDIS/NY

TDIS/N2Y

Principal dimensions				Basic load ratings		Fatigue load limit	Mass	Designation	Design variant/feature
d	D	T	B	C	C ₀				
mm/in.				kN		kN	kg	–	–
203,2 8	368,3 14.5	158,75 6.25	152,4 6.25	1 985	3 350	305	75	BT2B 332683/HA1	TDI/WIY2
240 9.4488	480 18.8976	220 8.6614	200 7.874	3 615	5 500	465	183	BT2B 332931	TDI/WIY2
254 10	438,15 17.25	165,1 6.5	165,1 6.5	2 685	4 250	365	100	BT2B 332536/HA1	TDI/WIY2
300 11.811	440 17.3228	105 4.1339	105 4.1339	1 076	2 040	180	48,5	332168	TDIS/NY
300,038 11.8125	422,275 16.625	150,812 5.9375	150,812 5.9375	2 177	4 750	400	70	331951	TDI/GWIY2
303,212 11.9375	495,3 19.5	263,525 10.375	263,525 10.375	4 919	9 800	750	212	BT2B 332685/HA1	TDIT/Y2
305,033 12.0092	560 22.0473	199,263 7.874	200 7.874	1 677	5 300	430	205	BT2B 334087/HA3	TDIS/N2Y
	560 22.0473	200 7.845	200 7.874	1 677	5 300	430	200	332068	TDIS/N2Y
305,07 12.0106	500 19.6851	200 7.874	200 7.874	2 734	5 200	425	150	332169 A	TDIS/N
	500 22.0473	200 7.844	200 7.844	2 734	5 200	425	150	332169 AA	TDIS/NY
	560 19.6851	199,237 7.874	199,237 7.874	3 102	5 300	430	200	331617	TDIS/N2Y
317,5 12.5	422,275 16.625	128,588 5.0625	128,588 5.0625	1 785	4 150	345	51,5	BT2B 328699 G/HA1	TDI/GWIY2
333,375 13.125	469,9 18.5	166,688 6.5625	166,688 6.5625	2 642	5 700	465	92,5	BT2B 328695 A/HA1	TDIT/Y2
342,9 13.5	533,4 21	139,7 5.5	146,05 5.75	1 373	4 400	365	115	331713 A	TDI/WIY2
	533,4 21	139,7 5.5	146,05 5.75	1 373	4 400	365	115	331713 B	TDI/GWIY2
343,052 13.506	457,098 17.996	122,238 4.8125	122,238 4.8125	1 610	3 400	280	54	332240 A	TDI/GWIY2



Dimensions		Calculation factors							Comparative data ¹⁾		Thrust factor K
d	d ₁ ≈	D ₁ ≈	r _{1,2} min.	r _{3,4} min	e	Y ₁	Y ₂	Y ₀	Load ratings radial C _F	axial C _{Fa}	
mm/in.	mm				–				kN		
203,2 8	237	310	3,3	3,3	0,4	1,7	2,5	1,6	490	193	1,45
240 9.4488	284	377	2,5	5	0,72	0,94	1,4	0,9	900	634	0,82
254 10	295	380	3,3	6,4	0,35	1,9	2,9	1,8	670	233	1,63
300 11.811	340	377	4	4	0,88	0,77	1,15	0,8	260	224	0,67
300,038 11.8125	327	375	3,3	3,3	0,33	2	3	2	540	176	1,73
303,212 11.9375	338	417	3,3	6,4	0,33	2	3	2	1 220	403	1,76
305,033 12.0092	355	450	3,3	6,4	0,88	0,77	1,15	0,8	765	657	0,67
	369	446	3,3	6	0,88	0,77	1,15	0,8	765	657	0,67
305,07 12.0106	352	405	6,4	4,8	0,88	0,77	1,15	0,8	680	582	0,67
	352	405	6,4	4,8	0,88	0,77	1,15	0,8	680	582	0,67
	369	446	3,3	18	0,88	0,77	1,15	0,8	765	657	0,67
317,5 12.5	341	382	1,5	3,3	0,31	2,2	3,3	2,2	440	137	1,83
333,375 13.125	364	419	3,3	3,3	0,33	2	3	2	655	217	1,73
342,9 13.5	393	474	3,3	3,3	0,33	2	3	2	620	202	1,76
	393	474	3,3	3,3	0,33	2	3	2	620	202	1,76
343,052 13.506	369	410	1,5	3,3	0,48	1,4	2,1	1,4	390	184	1,24

¹⁾ For additional information → Comparative load ratings for double row tapered roller bearings, page 685

8.8 Double row tapered roller bearings, TDI design

d 346,075 – 408,4 mm

13.625 – 16.0787 in.

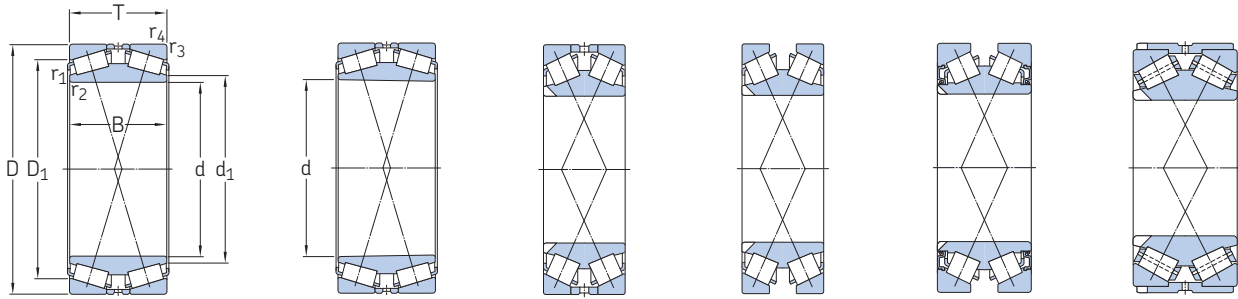

TDI/Y2

TDIT/Y2

TDIS/N

TDIS/NY

TDIS/NVY

TDIS.2/N

Principal dimensions				Basic load ratings		Fatigue load limit	Mass	Designation	Design variant/feature
d	D	T	B	C	C ₀				
mm/in.				kN		kN	kg	–	–
346,075 13.625	488,95 19.25	104,775 4.125	95,25 3.75	675	2 750	228	62	BT2B 332913/HB1	TDI/Y2
	488,95 19.25	174,625 6.875	174,625 6.875	2 835	6 300	510	110	331527 C	TDI/WIY2
	488,95 19.25	174,625 6.875	174,625 6.875	2 835	6 300	510	113	BT2B 328410 C/HA1	TDIT/Y2
360 14.1732	560 22.0473	160 6.2992	160 6.2992	2 556	4 650	390	140	BT2-8000/HA3	TDIS/N
368,3 14.5	523,875 20.625	185,738 7.3125	185,738 7.3125	3 380	7 500	585	133	BT2B 331836	TDI/Y2
	523,875 20.625	185,738 7.3125	185,738 7.3125	3 380	7 500	585	140	BT2B 332468 A/HA1	TDIT/Y2
380 14.9606	560 22.0473	200 7.874	200 7.874	1 617	6 550	520	165	BT2-8009/HA3	TDIS/NY
384,175 15.125	546,1 21.5	193,675 7.625	193,675 7.625	3 724	8 300	640	152	331158 A	TDI/GWIY2
	546,1 21.5	193,675 7.625	193,675 7.625	3 724	8 300	640	152	BT2B 331837	TDI/Y2
	546,1 21.5	193,675 7.625	193,675 7.625	3 724	8 300	640	166	BT2B 328580/HA1	TDIT/Y2
386 15.1969	574 22.5984	220 8.6614	220 8.6614	2 967	6 550	510	185	BT2-8010/HA3VA901	TDIS/NVY
390 15.3543	546,1 22.441	141,288 7.874	141,288 7.874	2 339	5 100	405	102	BT2B 328705/HA1	TDI/Y2
	570 21.5	200 5.5625	200 5.5625	2 967	6 550	510	170	BT2B 328896/HA3	TDIS/NY
	590 23.2284	200 7.874	200 7.874	2 967	6 550	510	200	BT2B 328934/HA3	TDIS.2/N
406,4 16	546,1 21.5	138,113 5.4375	138,113 5.4375	2 339	5 100	405	89	BT2B 331840 C/HA1	TDI/WIY2
408,4 16.0787	546,1 21.5	120 4.7244	98 3.8583	1 603	3 450	285	76,5	BT2B 328874/HA1	TDI/Y2
	546,1 21.5	150 5.9055	125 4.9213	1 963	4 750	375	99	BT2B 328466/HA1	TDI/Y2



Dimensions		Calculation factors							Comparative data ¹⁾		Thrust factor K
d	d ₁ ≈	D ₁ ≈	r _{1,2} min.	r _{3,4} min.	e	Y ₁	Y ₂	Y ₀	Load ratings radial C _F	axial C _{Fa}	
mm/in.	mm				–				kN		
346,075 13.625	391	429	1,5	6,4	0,5	1,35	2	1,3	300	148	1,17
	378	434	3,3	3,3	0,33	2	3	2	695	230	1,74
	378	434	3,3	3,3	0,33	2	3	2	695	230	1,74
360 14.1732	400	480	3	5	0,72	0,94	1,4	0,9	630	450	0,8
368,3 14.5	401	464	3,3	6,4	0,33	2	3	2	830	273	1,76
	401	464	3,3	6,4	0,33	2	3	2	830	273	1,76
380 14.9606	420	474	5	5	0,79	0,85	1,25	0,8	735	582	0,73
384,175 15.125	417	484	3,3	6,4	0,33	2	3	2	915	301	1,76
	417	484	3,3	6,4	0,33	2	3	2	915	301	1,76
	417	484	3,3	6,4	0,33	2	3	2	915	301	1,76
386 15.1969	416	498	3	5	0,83	0,81	1,2	0,8	735	599	0,71
390 15.3543	435	491	3,3	6,4	0,48	1,4	2,1	1,4	570	264	1,23
	426	475	5	5	0,83	0,81	1,2	0,8	735	599	0,71
	426	474	5	5	0,83	0,81	1,2	0,8	735	599	0,71
406,4 16	435	491	1,5	6,4	0,48	1,4	2,1	1,4	570	264	1,23
408,4 16.0787	442	480	1	3	0,88	0,77	1,15	0,8	390	329	0,68
	437	470	1,5	3,3	0,83	0,81	1,2	0,8	480	387	0,71

¹⁾ For additional information → Comparative load ratings for double row tapered roller bearings, page 685

8.8 Double row tapered roller bearings, TDI design

d 409,575 – 450 mm
16.125 – 17.7165 in.

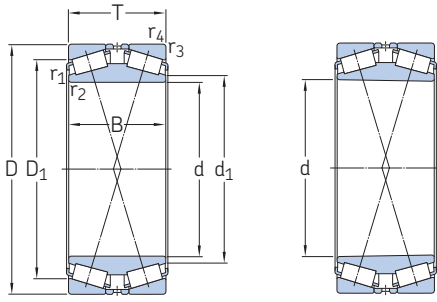

TDI/Y2

TDIT/Y2

Principal dimensions				Basic load ratings		Fatigue load limit	Mass	Designation	Design variant/feature
d	D	T	B	C	C ₀	P _u			
mm/in.				kN		kN	kg	–	–
409,575 16.125	546,1 21.5	161,925 6.375	161,925 6.375	2 669	6 550	500	110	331714 B	TDI/GWIY2
415,925 16.375	590,55 23.25	209,55 8.25	209,55 8.25	4 175	9 650	720	192	331445	TDI/GWIY2
	590,55 23.25	209,55 8.25	209,55 8.25	4 175	9 650	720	192	BT2B 328283/HA1	TDIT/Y2
430 16.9291	535 21.063	84 3.3071	84 3.3071	1 080	3 000	240	44,5	BT2B 334013/HA1	TDI/Y2
450 17.7165	595 23.4252	178 7.0079	178 7.0079	3 169	8 150	610	140	BT2B 328523/HA1	TDI/WIY2

Dimensions		Calculation factors							Comparative data ¹⁾		Thrust factor K
d	d ₁ ≈	D ₁ ≈	r _{1,2} min.	r _{3,4} min	e	Y ₁	Y ₂	Y ₀	Load ratings radial C _F	axial C _{Fa}	
mm/in.	mm				–				kN		
409,575 16.125	439	496	1,5	6,4	0,43	1,6	2,3	1,6	655	268	1,4
415,925 16.375	454	523	3,3	6,4	0,33	2	3	2	1 040	332	1,76
	455	523	3,3	6,4	0,33	2	3	2	1 040	332	1,76
430 16.9291	462	494	1	3	0,54	1,25	1,8	1,3	260	142	1,06
450 17.7165	488	540	3	6	0,33	2	3	2	780	256	1,76



¹⁾ For additional information → Comparative load ratings for double row tapered roller bearings, page 685